

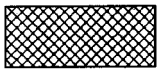

Rundschnüre



Vierkantschnüre



Sonderprofile



Schläuche



**Profile aus Gummi, Moosgummi,
Silikon, Schaum silikon**

Moosgummi-Profile

allseitig mit Haut

Liste Nr. 328

MZ

Moosgummi-Rundschnüre (MZR)

Ø mm	EPDM (EP)		Neoprene (CR)		Perbunan (NBR)		Silikon (SPS)		VITON® (FPM)	
	Farbe	Artikel-Nr.	Farbe	Artikel-Nr.	Farbe	Artikel-Nr.	Farbe	Artikel-Nr.	Farbe	Artikel-Nr.
1							w	5454		
1,5							w	5406		
2	s g	0206 2316	s	1471			w	3923		
2,5	s	0207	s	2686			w	5485		
3	s g	0208 1990	s	0209	g	0210	w	3213		
3,5	s	0211					w	5483		
4	s g	0212 1232	s	0213	g	0214	w	0489		
4,5	s	0215					w	1271		
5	s g	0216 1992	s	0217	g	0218	w	0490		
5,5							w	0491		
6	s g	0219 1989	s	0220	g	0221	w	0492		
6,5							w	0493		
7	s	0222	s	0223	g	0224				
8	s g	0225 1994	s	0226	g	0227	w	0495		
9	s	2179								
10	s g	0228 2314	s	0229	g	0230	w	0496		
11	s g	1233 2326			g	1235				
12	s g	0231 2327	s	0232	g	2293	w	0497		
13	s g	1234 2328			g	1236				
14	s g	0234 2095	s	1441	g	1440				

VITON[®] = Eingetragenes Warenzeichen der Firma DuPont

Moosgummi-Rundschnüre (MZR)

Ø mm	EPDM (EP)		Neoprene (CR)		Perbunan (NBR)		Silikon (SPS)		VITON® (FPM)	
	Farbe	Artikel-Nr.	Farbe	Artikel-Nr.	Farbe	Artikel-Nr.	Farbe	Artikel-Nr.	Farbe	Artikel-Nr.
15	s g	0235 2330	s	0236	g	0237	w	0498		
16	s g	0238 2332	s	0239	g	0240				
18	s g	0241 2333	s	0242	g	0243	w	0499		
20	s g	0244 2334	s	0245	g	0246	w	0500		
22	s g	1283 2335	s	1284	g	1285	w	5484		
25	s g	0247 2336	s	0248	g	0249	w	1371		
30	s g	0250 2337	s	0251	g	0252	w	3885		
35	s g	0253 2338	s	0254	g	0255				
40	s	0256								
45	s	0257								
50	s	0258								

Moosgummi-Vierkantprofile (MZV)

s = schwarz g = grau w = weiß rb = rotbraun
SK = Selbstklebung

mm		EPDM			Neoprene			Perbunan			Silikon			Sonstige		
Höhe	Breite	Farbe	Artikel-Nr.	mit SK Artikel-Nr.	Farbe	Artikel-Nr.	mit SK Artikel-Nr.	Farbe	Artikel-Nr.	mit SK Artikel-Nr.	Farbe	Artikel-Nr.	mit SK Artikel-Nr.	Farbe	Artikel-Nr.	mit SK Artikel-Nr.
1,5	20										w	3556	3557			
2	8	s g	0001 2342	0686 2445	s	0005	0663	g	0006	0662						
2	10	s g	0004 2343	0712 2446	s	0002	0687	g	0003	0688						
2	15	s g	0007 2344	0714 2447	s	3251	3253	g	0008	0715						
2	20	s g	0009 2345	0716 2448	s	3887	5510	g	0010	0717	w	0205	0487			
2	25	s g	3114 3118	3115 3123												
2	30										w	5511	3920			
2	50	s g	3113 3119	3116 3121												
3	5	s	3348	3563							w	0407	0488			
3	8										w	3568	3569			
3	10	s g	0011 2346	0718 2449	s	0013	0719	g	0012	0720	w	0408	0578			
3	15	s g	0014 2347	0721 2450	s	0016	0722	g	0015	0723	w	0409	0579			
3	16										w	0410	0580			
3	18	s g	0017 2348	0724 2451				g	0018	0913						
3	20	s g	0019 2349	0725 2452	s	0021	0726	g	0020	0727	w	0411	0581			
3	25				g	2266	5512				w	0412	0582			
3	30	s g	0022 2350	0728 2453	s	0024	0729	g	0023	0730	w	0413	0583			
3	35										w	0437	0584			
3	40	s g	0025 2351	0731 2454	s	0027	0732	g	0026	0733						
3	50	s	3570	3571	s	1059	5513									
4	5	s	3788	5514							w	0415	0585			
4	6	s	3366	3399	s	3975	5515									
4	8	s g	0028 2352	0741 2455	s	0030	0742	g	0029	0743						
4	10	s g	0031 2353	0744 2456	s	0033	0745	g	0032	0746	w rb	0416 3028	0586			
4	12	s g	0034 2354	0747 2457	s	0036	0748	g	0035	0749						

Moosgummi-Vierkantprofile (MZV)

s = schwarz g = grau w = weiß rb = rotbraun
SK = Selbstklebung

mm		EPDM			Neoprene			Perbunan			Silikon			Sonstige		
Höhe	Breite	Farbe	Artikel-Nr.	mit SK Artikel-Nr.	Farbe	Artikel-Nr.	mit SK Artikel-Nr.	Farbe	Artikel-Nr.	mit SK Artikel-Nr.	Farbe	Artikel-Nr.	mit SK Artikel-Nr.	Farbe	Artikel-Nr.	mit SK Artikel-Nr.
5	70	g	5488	5649							g	3512				
5	80										g	3242				
6	6	s g	0071 2367	3222 3223	s	0073	2174	g	0072	3224	w	3674	3724			
6	8	s g	3426 3524	5524 5525							w	0483	0608			
6	10	s g	0074 2250	0782 2469	s	0076	0783	g	0075	0784						
6	12	s g	0077 2369	0785 2470	s	0484	0786	g	0078	0787						
6	15	s g	0079 2370	0788 2471	s	0081	0789	g	0080	0790	w	0431	0602			
6	16	s	1318	5527				s	5629	5630	w	0432	0603			
6	20	s g	0082 2371	0791 2472	s	0084	0792	g	0083	0793	w	0433	0604			
6	25	s g	0085 2372	0794 2473				g	0086	0795						
6	30	s g	0087 2373	0796 2474	s	0089	0797	g	0088	0798						
6	35	s g	0090 2374	0799 2475	s	4557	5528	s g br	3166 0091 1472	0800 5529						
6	40	s g	0092 2375	0801 2476				g	0093	0802	w	0434	0605			
6	50	s g	2697 2696	2821 2822	s	2415	5530				w	0435	0606			
7	10	s g	0094 2376	0803 2477												
7	12										w	4455	5531			
7	15	s	3365	3401							w	0436	0607			
7	20	s g	0095 2377	0804 2478				g	5532	0805						
8	8	s g	0097 2388	0806 2479	s	0099	0807	g	0098	0808	w	0439	0609			
8	10	s g	0100 2378	0809 2480	s g	0101 2684	0810	g	1257	1266	w	0440	0610			
8	12	s g	0102 2379	0811 2481	s g	0104 1258	0812 1269	g	0103	0813						
8	14										w	0441	0611			
8	15	s g	0105 2380	0814 2482	s	0106	0815				w	0442	0612			
8	16	s g	0107 2381	0816 2483	s	3391	3402	g	1395	5533						
8	18	s g	0108 2382	0817 2484	s	4549	5534	g	0109	0818						

Moosgummi-Vierkantprofile (MZV)

s = schwarz g = grau w = weiß rb = rotbraun
SK = Selbstklebung

mm		EPDM			Neoprene			Perbunan			Silikon			Sonstige		
Höhe	Breite	Farbe	Artikel-Nr.	mit SK Artikel-Nr.	Farbe	Artikel-Nr.	mit SK Artikel-Nr.	Farbe	Artikel-Nr.	mit SK Artikel-Nr.	Farbe	Artikel-Nr.	mit SK Artikel-Nr.	Farbe	Artikel-Nr.	mit SK Artikel-Nr.
8	20	s g	0110 2383	0819 2485	g	0112	0820	g	0111	0821	w	0443	0613			
8	24										w	0444	0614			
8	25	s g	0113 2384	0822 2486	g	0115	0823	g	0114	0824						
8	30	s g	0116 2386	0825 2487	s	0117	0826									
8	35							g	1255		w	0445	0615			
8	38										w	0446	0616			
8	40	s g	0118 2387	0827 2488	s	0120	0828	s g	1426 0119	5535 0829						
8	50	s g	2658 2697	2823 2824	s	3358	5536									
9	9	s	3508	5576												
9	12	s	3817	5541												
9	13										w	0447	0617			
9	16	s g	0121 2391	0830 2489												
9	20										w	0449	0619			
9	23	s g	2017 2830	2831 2832												
9,5	14										w	0448	0618			
10	10	s g	0122 2392	0831 2490	s	0124	0833	g	0123	0834	w	1272	1274			
10	12	s g	0125 1270	0835 2491	s g	0127 1418	0836	g	0126	0926	w	3574	3774			
10	15	s g	0128 2396	0837 2492	s	0130	0838	g	0129	0839	w	0450	0620			
10	16	s g	2094 2826	2825 2827	s	3573	5537									
10	18	s g	0131 2397	0840 2493	s	2274	5538				w	2013	5539			
10	20	s g	0132 2398	0841 2494	s	0134	0842	g	0133	0843	w	0451	0621	EPDM 25° Sh s 1546		
10	23	s	3750	5542												
10	25	s g	0135 2399	0844 2495	s	0137	0845	g	0136	0846	w s	0452	0622 4365			
10	30	s g	0138 2400	0847 2496	s	0140	0848	g	0139	0849	w	0453	0623	EPDM 25° Sh s 1549		
10	35	s g	3111 3120	3117 3122							w	0454	0624	EPDM 25° Sh s 4814		

Moosgummi-Vierkantprofile (MZV)

s = schwarz g = grau w = weiß rb = rotbraun
SK = Selbstklebung

mm		EPDM			Neoprene			Perbunan			Silikon			Sonstige		
Höhe	Breite	Farbe	Artikel-Nr.	mit SK Artikel-Nr.	Farbe	Artikel-Nr.	mit SK Artikel-Nr.	Farbe	Artikel-Nr.	mit SK Artikel-Nr.	Farbe	Artikel-Nr.	mit SK Artikel-Nr.	Farbe	Artikel-Nr.	mit SK Artikel-Nr.
10	40	s g	0141 2401	0850 2497	s	0143	0851	g	0142	0852				EPDM 25° Sh s 2663		
10	45	s	1197	5540							w	0455	0625			
10	50	s g	0144 2402	0853 2498	s	0146	0854	g	0145	0855				Naturkautschuk g 3061 3062		
														EPDM 25° Sh s 4818		
10	60	s g	3952 4591	4197 5543												
10	70	s g	3392 4592	3393 5544	s	4087	5545									
11	16										w	0456	0626			
12	12	s g	0147 2404	0856 2499	s	0149	0857	g	0148	0858	w	0460	0627			
12	15	s g	0150 2406	0859 2500	s	0152	0860	g	0151	0927	w	0471	0628			
12	17				s	4027	5578									
12	18	g	3876	5557												
12	20	s g	0153 2407	0861 2501	s g	1264 1473	1268 5546	g	0154	0862						
12	25	s g	0155 2408	0863 2502	s g	4558 0157	0864	g	0156	0865						
12	28	g	4193	558												
12	30	s g	4152 4671	5547 5548				s	3743	5549	w	0472	0629			
12	35										w	0473	0630	EPDM 25° Sh s 4815		
12	40	s g	0158 2405	0866 2503				g	0159	0867	w	0474	0631			
12	45	g	4192	5559												
12	50	s	0147	5560												
15	15	s g	0160 2409	0868 2504	s	0162	0869	g	0161	0870	w	0475	0632	EPDM 25° Sh s 4813		
15	17										w	0476	0633			
15	18	g	3511	5561												
15	18,5										w	0477	0634			
15	20	s g	0163 2410	0871 2505	s	0165	0872	g	0164	0873	w rb	0478 3205	0635	EPDM 25° Sh s 2664		
15	25	s g	0166 2411	0874 2506	s	0168	0875	g	0167	0876	w g	0479 4342	0636	EPDM 25° Sh s 4249		

Moosgummi-Vierkantprofile (MZV)

s = schwarz g = grau w = weiß rb = rotbraun
SK = Selbstklebung

mm		EPDM			Neoprene			Perbunan			Silikon			Sonstige		
Höhe	Breite	Farbe	Artikel-Nr.	mit SK Artikel-Nr.	Farbe	Artikel-Nr.	mit SK Artikel-Nr.	Farbe	Artikel-Nr.	mit SK Artikel-Nr.	Farbe	Artikel-Nr.	mit SK Artikel-Nr.	Farbe	Artikel-Nr.	mit SK Artikel-Nr.
20	40	s g	0186 2421	0894 2514	s	0188	0895	s g	4599 0187	5566 0896	w	3891	5567			
20	45	s g	0190 2423	0897 2515												EPDM 25° Sh s 1532
20	50	s g	0189 2422	0898 2516	s	1256	1267				w	0464	0647			EPDM 25° Sh s 4820
20	60	s	4115	4116	s	4595	5568	s	4071	4112						EPDM 25° Sh s 5318
20	70										w	0465	0648			
22	22										w	0466	0649			
23	25	s	2214	5580							w	0467	0650			
24	24										w	0468	0651			
25	25	s g	0191 2424	0899 2517	s	0193	0900	g	0192	0901	w g	0469 4341	0652			EPDM 25° Sh s 1548
25	33	s	3910	5571												
25	30	s g	0194 2425	0902 2518	s	0196	0903	g	0195	0904	w	3185	3187			EPDM 25° Sh s 2739
25	35	s g	2991 2992	3384 5569												EPDM 25° Sh s 2742
25	40	s g	0197 2426	0905 2519	s	0198	0906	g	3687	5570						EPDM 25° Sh s 1552
25	45															EPDM 25° Sh s 5253
25	50	s	1328	4254												EPDM 25° Sh s 4821
25	65										w	3827				
30	30	s g	0199 2428	0907 2520	s	0200	0908	g	3405	3847	w	0470	0653			EPDM 25° Sh s 1550
30	35	s	1297	5572												EPDM 25° Sh s 2766
30	40	s g	0201 2429	0909 2521	s	4594	5573	g	0202	0910	g	4434				EPDM 25° Sh s 1531
30	50	s g	0203 2430	0911 2522	s	4559	5574	g	0204	0912	w	3550	5578			EPDM 25° Sh s 4822
35	35										w	2160	2162			EPDM 25° Sh s 4816
35	40															EPDM 25° Sh s 5254
40	40	s	3730	3731	s	3732	3733				w	2794	2796			EPDM 25° Sh s 4825
40	50	s	3708	3711	s	2548	5573									EPDM 25° Sh s 4824
40	60	s	5393	5575												EPDM 25° Sh s 5289

Moosgummi-Vierkantprofile (MZV)

s = schwarz **g** = grau **w** = weiß **rb** = rotbraun
SK = Selbstklebung

mm		EPDM			Neoprene			Perbunan			Silikon			Sonstige		
Höhe	Breite	Farbe	Artikel-Nr.	mit SK Artikel-Nr.	Farbe	Artikel-Nr.	mit SK Artikel-Nr.	Farbe	Artikel-Nr.	mit SK Artikel-Nr.	Farbe	Artikel-Nr.	mit SK Artikel-Nr.	Farbe	Artikel-Nr.	mit SK Artikel-Nr.
45	45	s	5261	5574												EPDM 25° Sh s 5250
45	50	s	4154	4343												EPDM 35° Sh s 4154 4343
50	50	s	3709	3710												EPDM 25° Sh s 4823

Zeichenerklärung

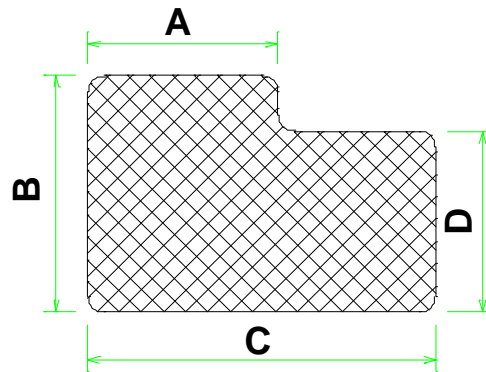

25999

bedeutet

Profil-Nr.

EP / s / 9999 / (9998)

bedeutet *Qualität / Farbe / Artikel-Nr. / (Artikel-Nr. mit es.sk)*

es.sk = einseitig selbstklebend

Qualität

CR	Neoprene
EP	EPDM
NBR	Perbunan
NK	Naturkautschuk
Si	Silikon
SPS	Silikonschaum
FPM	VITON®
-FR	selbst verlöschend

Farbe

s	schwarz
g	grau
w	weiß
az	anthrazit
bg	beige
br	braun
hg	hellgrau
rb	rotbraun
t	transparent

Abkürzungen

MZR	Moosgummi-Rundschnur	SSR	Silikonschaum-Rundschnur
MZV	Moosgummi-Vierkantprofil	SSV	Silikonschaum-Vierkantprofil
MZVS	Moosgummi-Vierkantprofil es.sk	SSVS	Silikonschaum-Vierkantprofil es.sk
MZS	Moosgummi-Sonderprofil	SSS	Silikonschaum-Sonderprofil
MZSS	Moosgummi-Sonderprofil es.sk	SSSS	Silikonschaum-Sonderprofil es.sk

â = Eingetragenes Warenzeichen der Firma DuPont

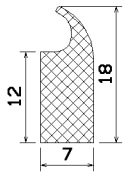

25001

EP/g/ 3277
NK/g/ 0259

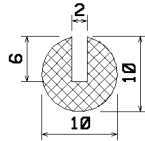

25002

EP/s/ 0260

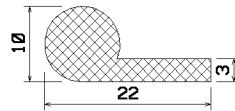

25003

EP/s/ 0261

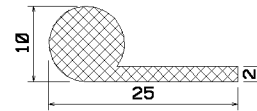

25004

EP/s/ 0262/(4464)

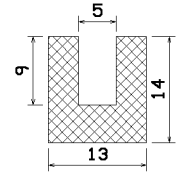

25005

EP/s/ 0263

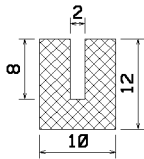

25006

EP/s/ 0264

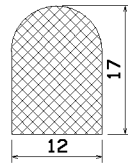

25007

EP/s/ 0265/(1182)
EP/g/ 0266
CR/s/ 0267
NBR/g/ 0268
NBR/s/ 3742

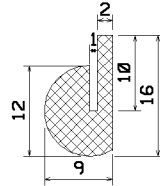

25008

EP/s/ 0269

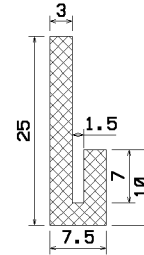

25009

EP/s/ 0270

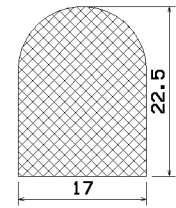

25010

CR/g/ 0271

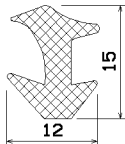

25011

EP/s/ 0272

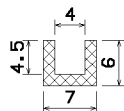

25012

EP/s/ 0273

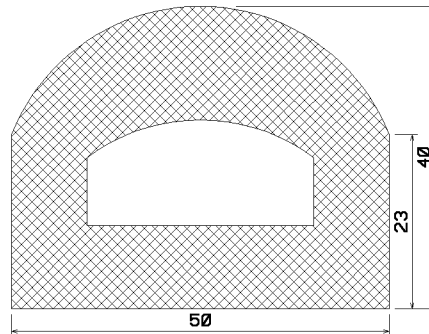

25013

EP/s/ 0274

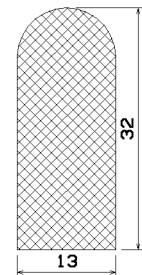

25014

NBR/s/ 0275

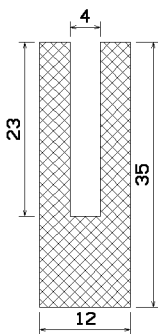

25015

EP/s/ 0276

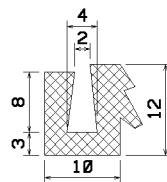

25017

EP/s/ 0277

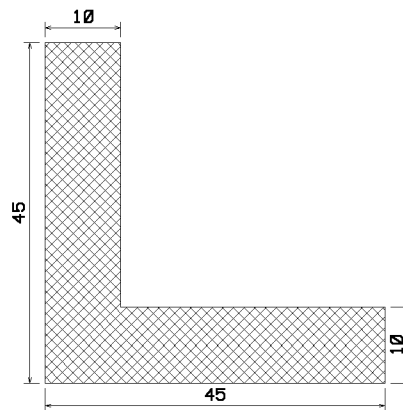

25018

EP/s/ 0278

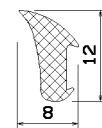

25020

EP/s/ 0280

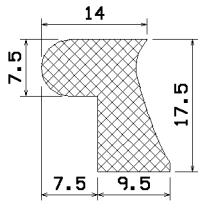

25021
EP/s/0281
EP/g/0282

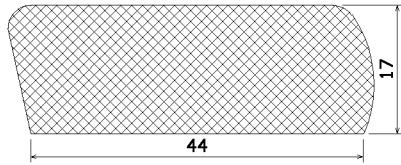

25023
EP/s/0284

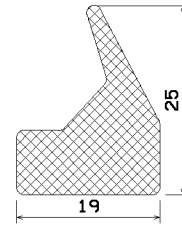

25024
EP/g/0285

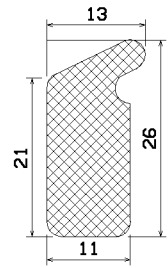

25026
CR/s/0286

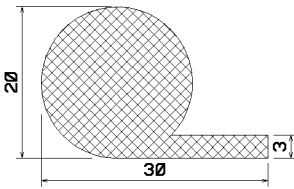

25027
NBR/s/0287

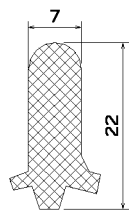

25028
EP/g/0288

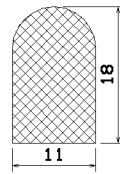

25029
EP/g/0289

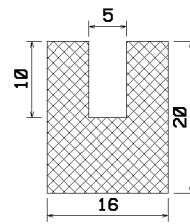

25031
EP/s/0290

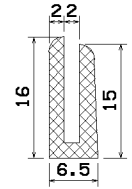

25032
EP/s/0291

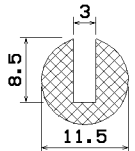

25033
EP/s/0292

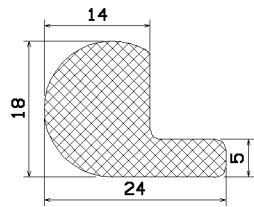

25034
EP/s/0293

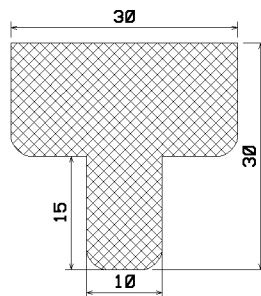

25035
EP/s/0294

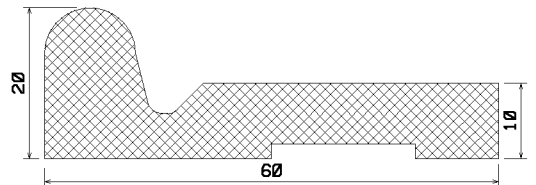

25036
EP/s/0295

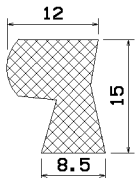

25037
EP/s/0296
EP/g/4159

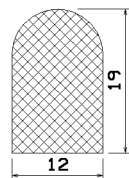

25038
NBR/s/0297

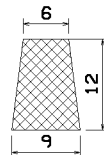

25039
EP/s/0298

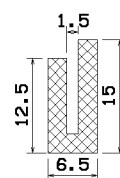

25040
EP/s/0299/(1128)

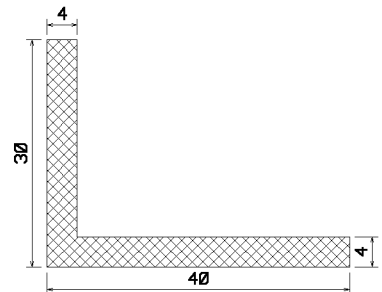

25041
EP/s/0300

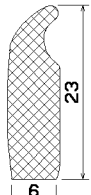

25042
NK/s/0301

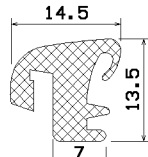

25043
EP/s/0302

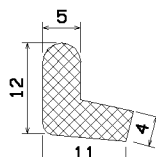

25044
EP/s/0303

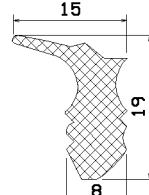

25045
EP/s/2064

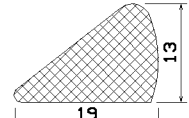

25046
CR/g/0305

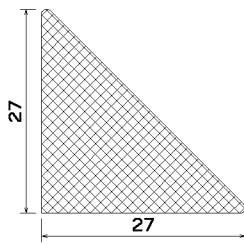

25047
EP/s/3343
NBR/g/2236

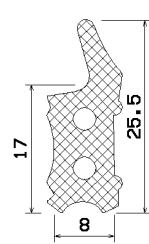

25048
EP/s/0307

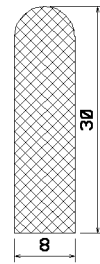

25049
EP/s/0308

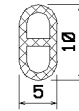

25050
EP/s/0309



25052
CR/s/0310



25053
CR/g/0311

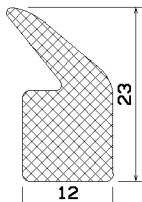

25054
CR/s/0312
EP/w/3686

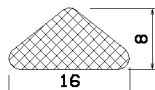

25055
CR/s/0313

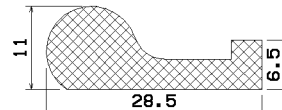

25056
EP/s/0314

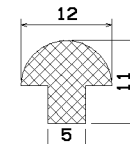

25057
EP/g/0315

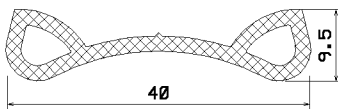

25058
EP/s/0316

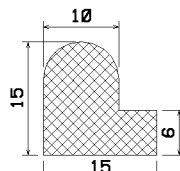

25059
EP/s/0317

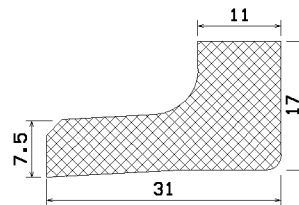

25061
EP/s/0318

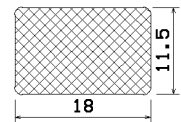

25062
NBR/g/0319

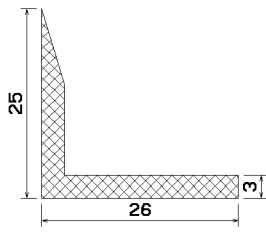

25064

EP/s/0320

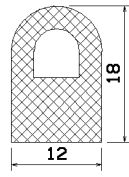

25065

EP/g/0321



25066

EP/s/0322

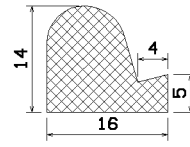

25067

EP/s/0323

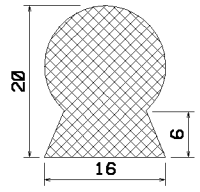

25068

EP/s/0324

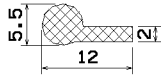

25069

EP/s/0325

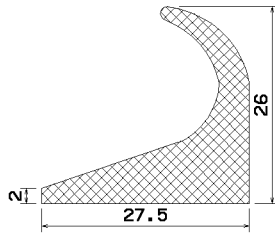

25071

EP/s/0326

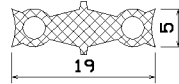

25072

EP/s/0327

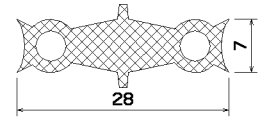

25073

EP/s/0328

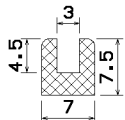

25074

EP/s/0329

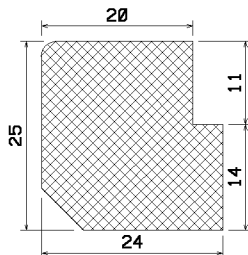

25075

NBR/s/0330

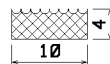

25076

EP/g/0331

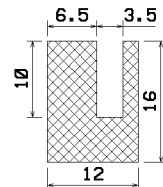

25077

NBR/s/0332

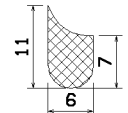

25078

EP/s/0333

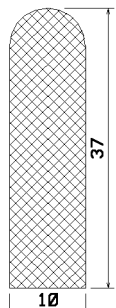

25079

EP/g/0334

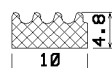

25080

EP/s/1446/(2183)
EP/g/0335

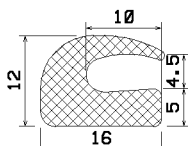

25081

EP/s/0336

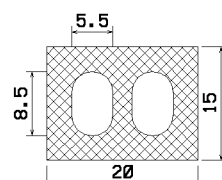

25082

EP/s/0337/(2272)

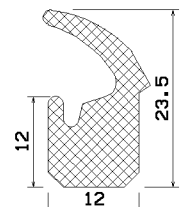

25083

EP/s/0338



25084

EP/w/0339

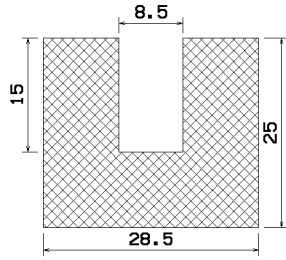

25085

EP/s/0340

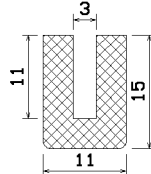

25086

EP/s/0341
EP/g/3856

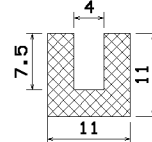

25087

EP/s/0342

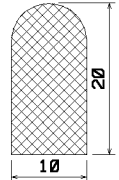

25088

EP/s/0343/(4146)
EP/g/3091

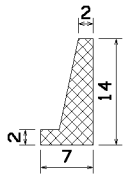

25089

CR/s/0344

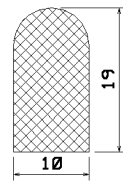

25091

EP/s/0345

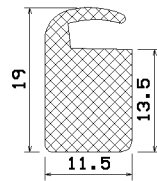

25092

EP/s/0346

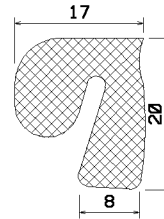

25093

EP/s/0347

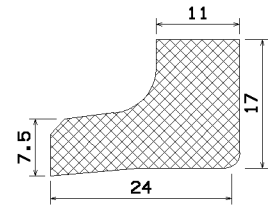

25094

EP/s/0348

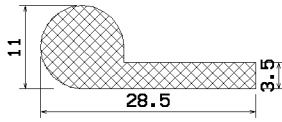

25095

EP/s/0349

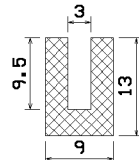

25096

EP/s/0350

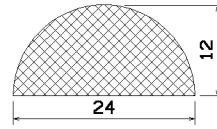

25097

EP/s/0351

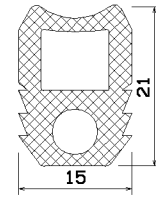

25098

EP/s/0352

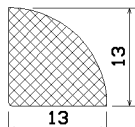

25099

NBR/g/0353

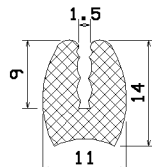

25101

EP/s/0354

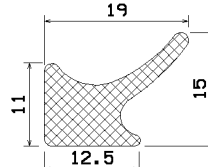

25102

EP/s/0355

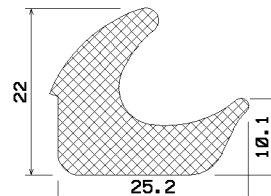

25103

EP/s/0356

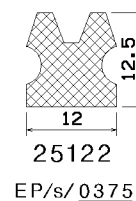
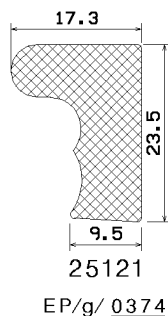
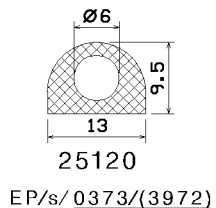
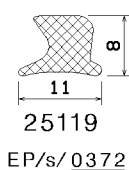
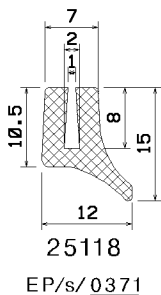
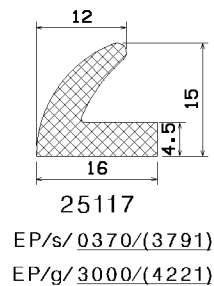
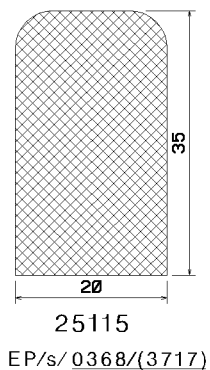
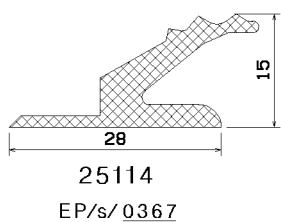
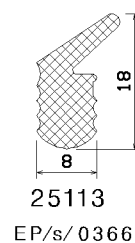
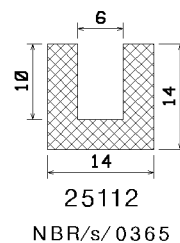
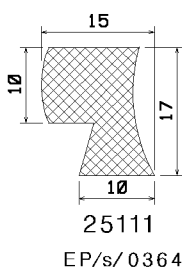
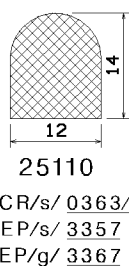
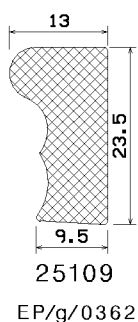
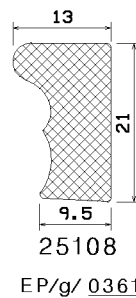
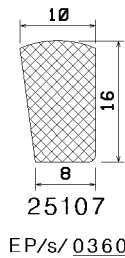
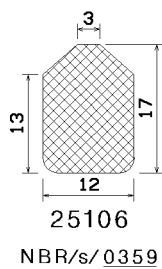
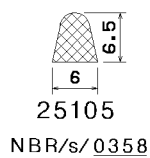
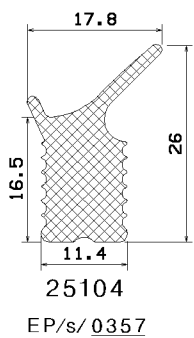

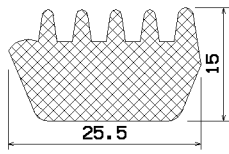

25123
EP/s/ 0376

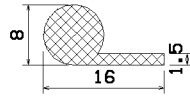

25124
EP/s/ 0377

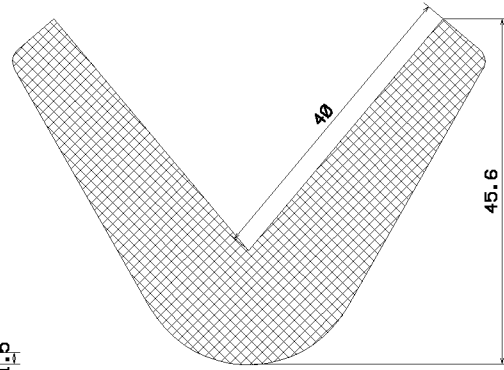

25125
EP/s/ 0378

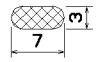

25126
EP/g/ 0379

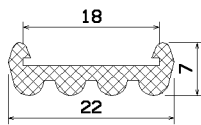

25127
EP/s/ 0380

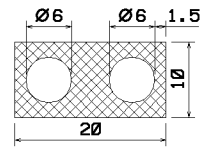

25128
EP/s/ 0381/(3294)

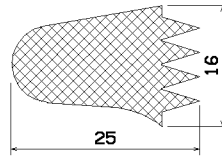

25129
EP/s/ 0382

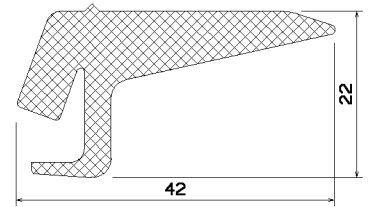

25130
EP/s/ 0383

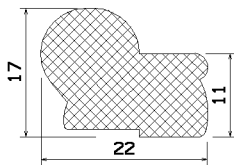

25131
EP/s/ 0384

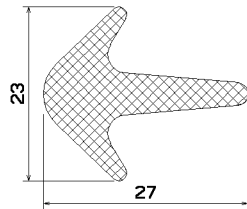

25132
EP/s/ 0385

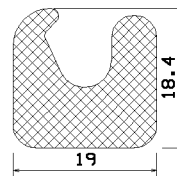

25133
EP/s/ 0386

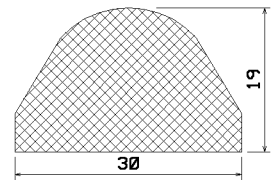

25134
CR/s/ 0387

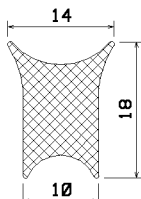

25135
EP/s/ 0388

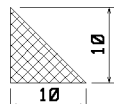

25136
EP/s/ 0389/(4156)

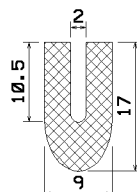

25137
EP/s/ 0390

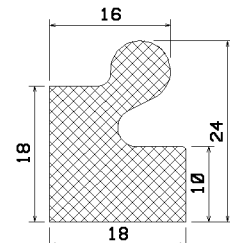

25138
NBR/s/ 0391

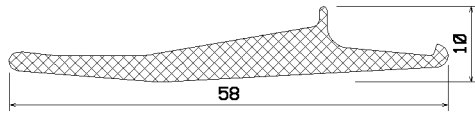

25139
EP/s/ 0392

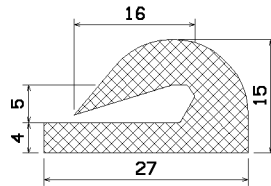

25140
EP/s/ 0393

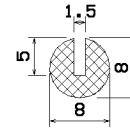

25141
EP/s/ 0394

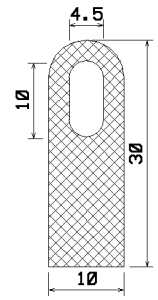

25142
EP/s/ 0395

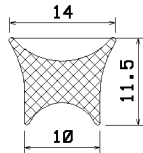

25143
EP/s/ 0396

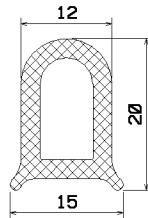

25144
NBR/s/ 0397

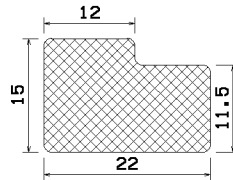

25146
CR/g/ 0399

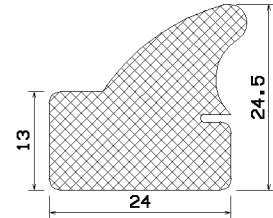

25147
EP/s/ 0400

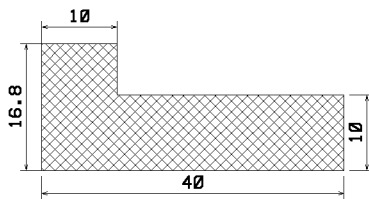

25148
EP/s/ 0401

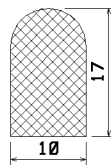

25149
EP/s/ 0402
EP/g/ 1416

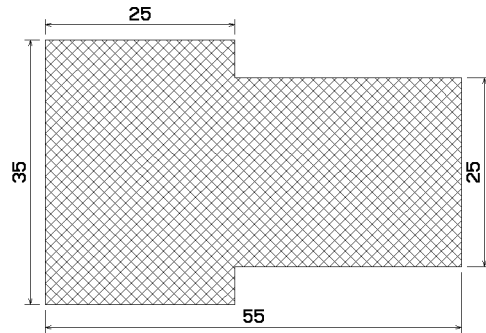

25150
EP/g/ 0403

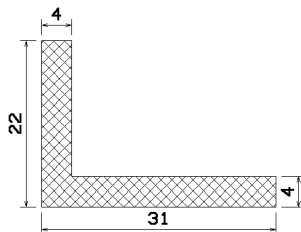

25151
EP/s/ 0404

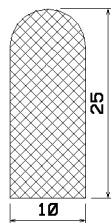

25152
EP/g/ 0405
NK/g/ 4111

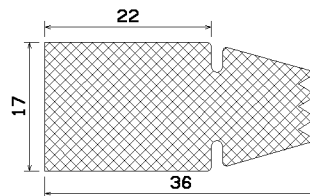

25153
CR/g/ 0406

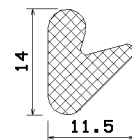

25154
EP/s/ 0734

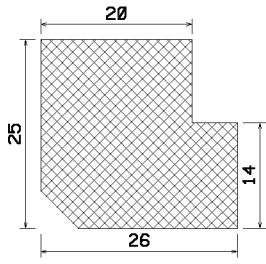

25155
NBR/s/ 0735

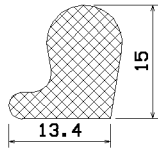

25156
EP/g/ 0736

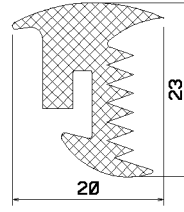

25157
EP/s/ 0737

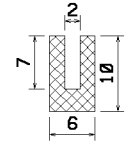

25158
EP/w/ 0738
EP/s/ 3390

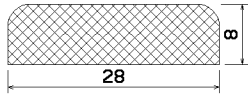

25159
EP/s/ 0739

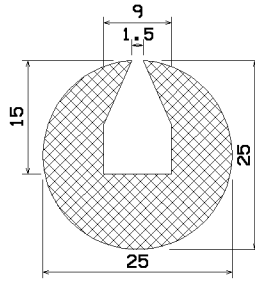

25160
EP/s/ 0740

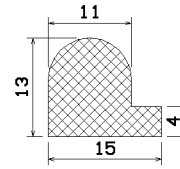

25161
EP/g/ 1016

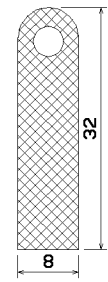

25162
EP/s/ 1259

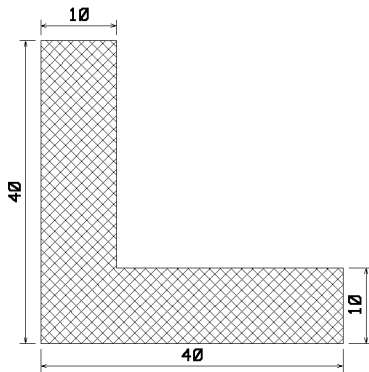

25163
EP/s/ 1260/(4394)

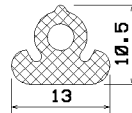

25164
EP/s/ 1261

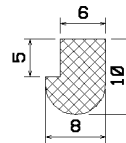

25165
CR/s/ 1262

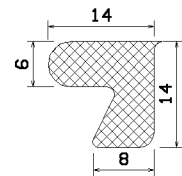

25166
EP/w/ 1263
EP/g/ 4149

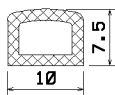

25167
EP/g/ 1216/(1215)
EP/s/ 1286/(2113)

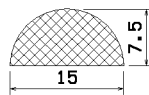

25168
EP/g/ 3058/(3060)
NK/g/ 1287
CR/s/ 6449

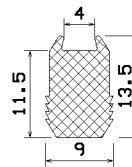

25169
EP/s/ 1288

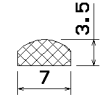

25170
EP/s/ 1289

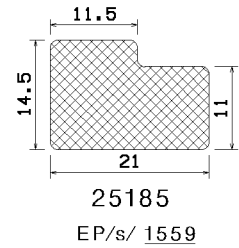
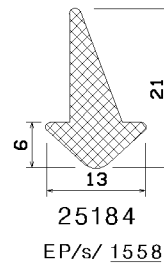
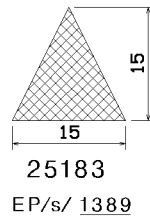
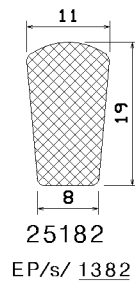
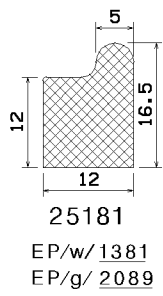
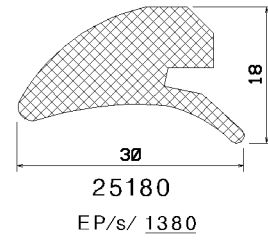
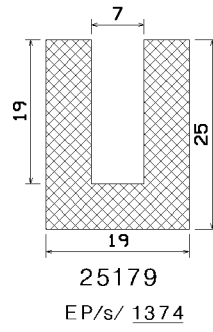
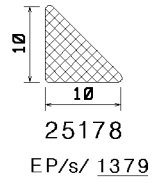
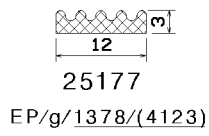
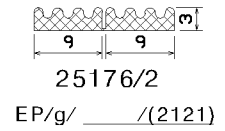
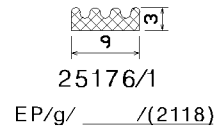
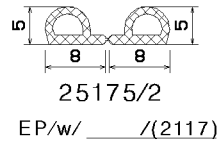
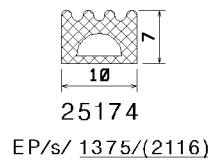
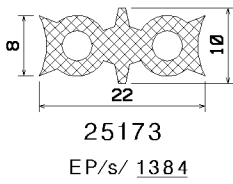
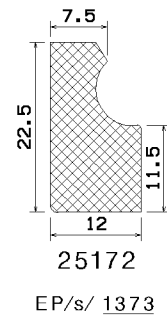
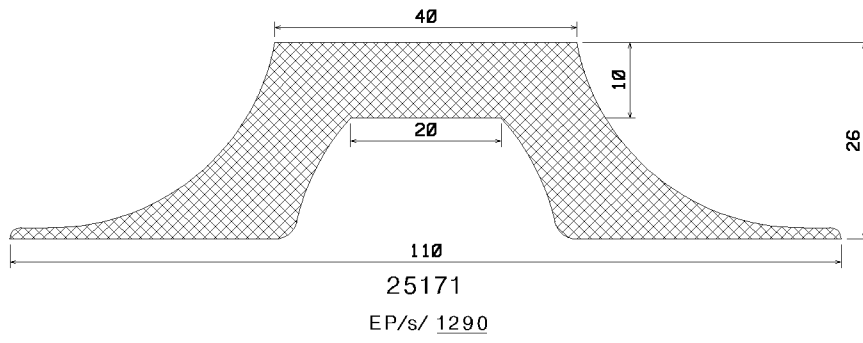

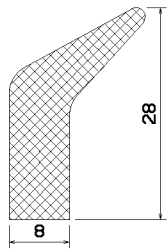

25186

EP/s/ 1524

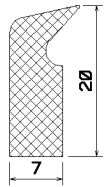

25187

EP/s/ 1525

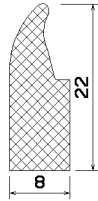

25188

EP/s/ 1526

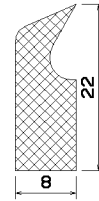

25189

EP/s/ 1527

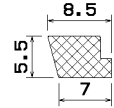

25191

EP/s/ 2000

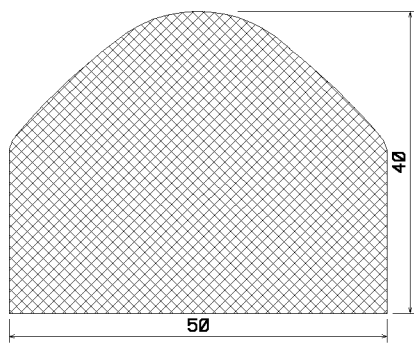

25192

EP/s/ 1998

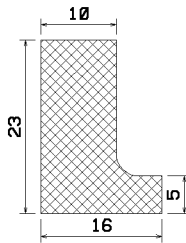

25193

EP/s/ 2067

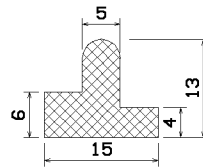

25194

EP/g/ 2153

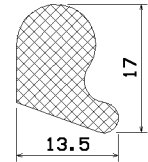

25195

EP/g/ 2154

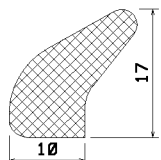

25196

EP/g/ 2152

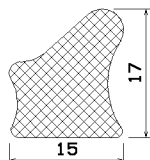

25197

EP/g/ 2155

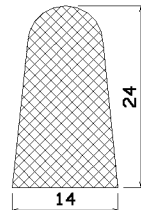

25198

EP/g/ 2156

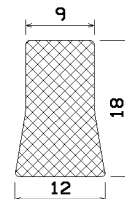

25199

EP/g/ 2157

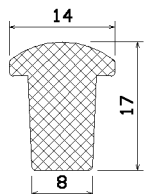

25200

EP/s/ 2108

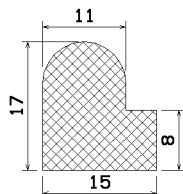

25201

EP/g/ 2151

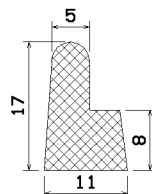

25202

EP/g/ 2158

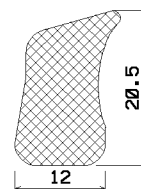

25203

EP/g/ 2166

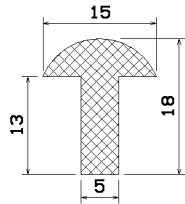

25204
EP/g/ 2170

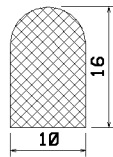

25205
EP/g/ 2167

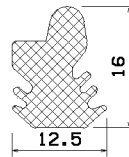

25206
EP/g/ 2171

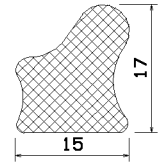

25207
EP/g/ 2172

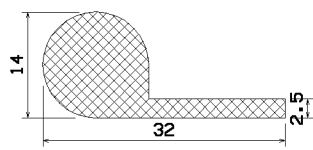

25208
EP/s/ 2168
EP/g/ 2754

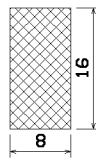

25209
CR/s/ 2192

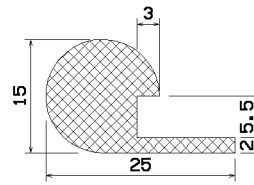

25210
EP/g/ 2208

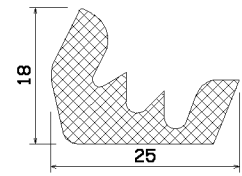

25211
EP/s/ 2205

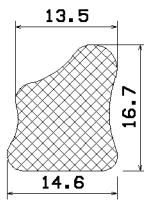

25212
EP/g/ 2215

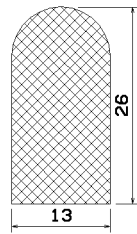

25213
CR/s/ 2223

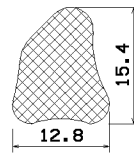

25214
EP/g/ 2247

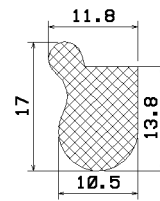

25215
EP/g/ 2246

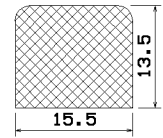

25216
EP/g/ 2249

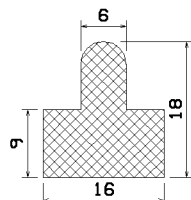

25217
EP/g/ 2248

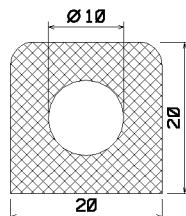

25218
CR/s/ 2300

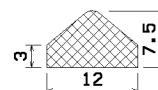

25219
EP/s/ 2670/(2874)

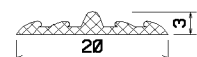

25220
EP/s/ 2329

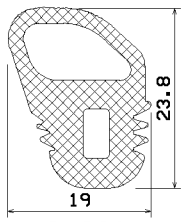

25221

EP/s/ 2434



25222

EP/g/ 2789/
es. SK (2792)
bds. SK (2793)

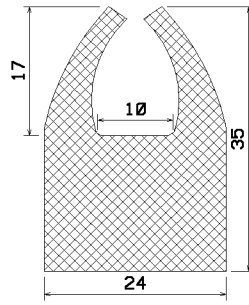

25223

CR/s/ 2862

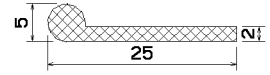

25224

EP/s/ 2863/(4348)

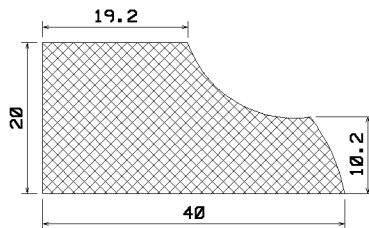

25225

EP/s/ 2873

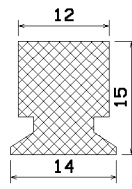

25226

CR/s/ 2904

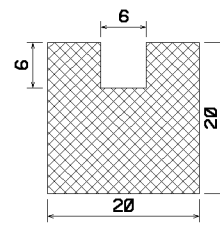

25227

EP/s/ 2928

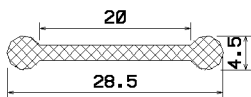

25228

EP/s/ 2938

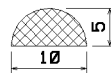

25229

EP/s/ 2937/(3032)
EP/g/ 3340/(2224)
CR/s/ 6444

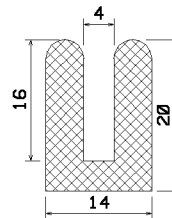

25230

EP/g/ 2947

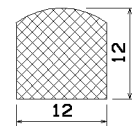

25231

CR/s/ 2984

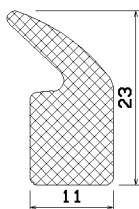

25232

EP/g/ 2996

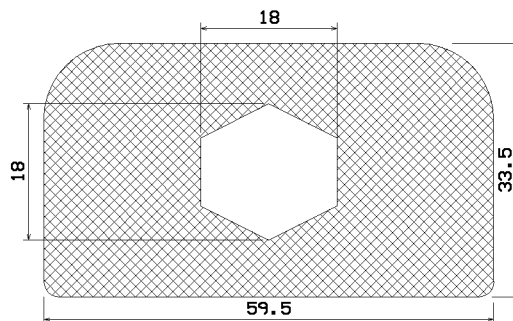

25233

NBR/s/ 2997

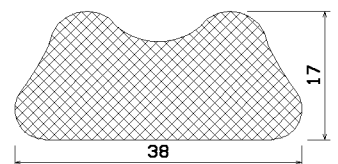

25235

NBR/s/ 3009

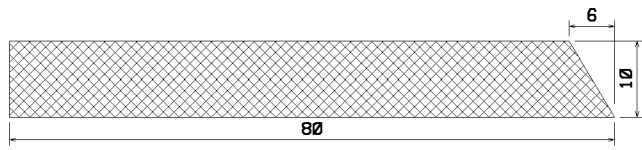

25234
EP/s/ 2995

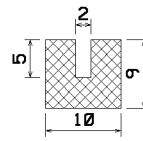

25236
EP/g/ 3004

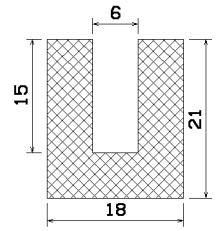

25237
EP/s/ 3010
EP/g/ 3309

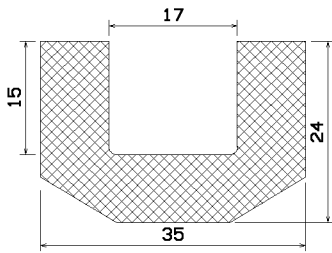

25238
EP/s/ 3005

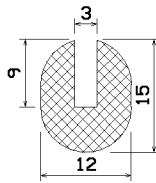

25239
EP/s/ 3014

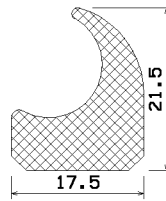

25240
EP/g/ 3003

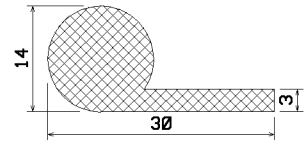

25241
EP/s/ 3012/(3766)
EP/g/ 3006

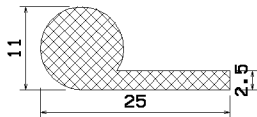

25242
EP/g/ 3002

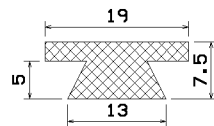

25243
EP/g/ 2999

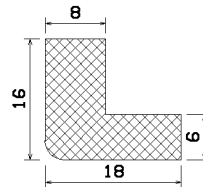

25244
EP/s/ 2998



25245
EP/s/ 3013/(3158)

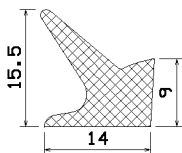

25246
EP/s/ 3016

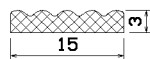

25247
EP/g/ 4349/(3026)

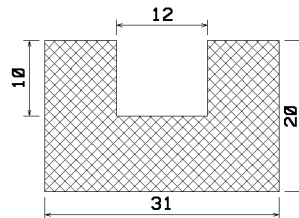

25248
EP/s/ 3048/(4303)

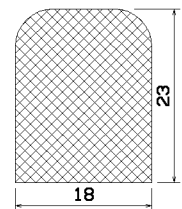

25249
NBR/g/ 3036

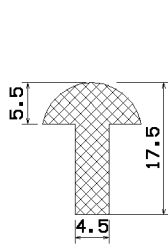

25250

EP/g/ 3034

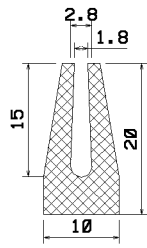

25251

EP/s/ 3043

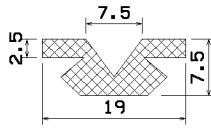

25252

EP/g/ 3057



25253

EP/s/ 3054/(2018)

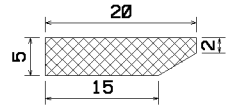

25254

EP/s/ 3045

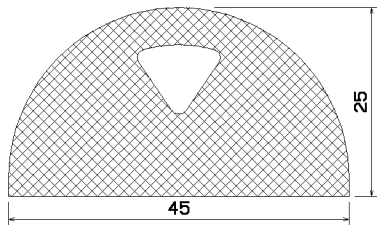

25255

EP/s/ 3097

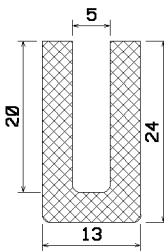

25256

EP/s/ 3044

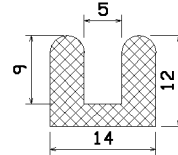

25257

EP/s/ 3055

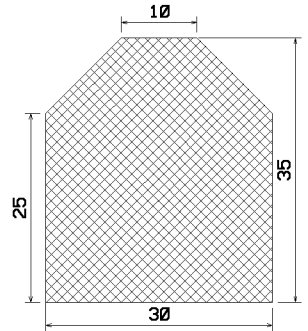

25258

EP/s/ 3056

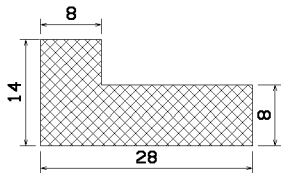

25259

EP/s/ 3068

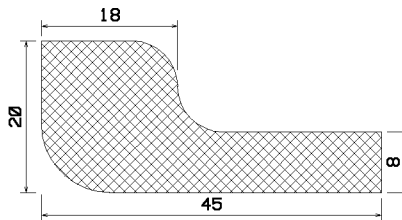

25260

EP/s/ 3076

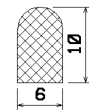

25261

EP/g/ 3090
EP/s/ 3539

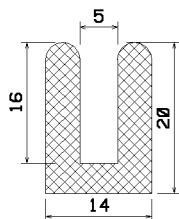

25262

EP/g/ 3089

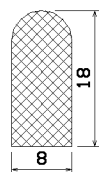

25263

EP/g/ 1308
EP/s/ 3149

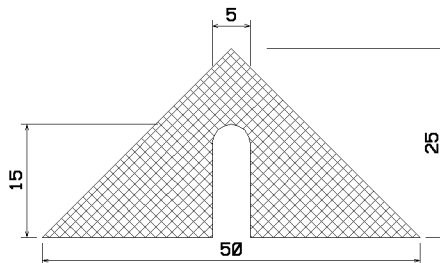

25264

EP/s/ 3098

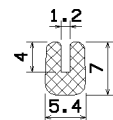

25265

EP/g/ 3136
EP/s/ 3681

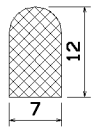

25266
EP/g/ 1189
EP/s/ 3107

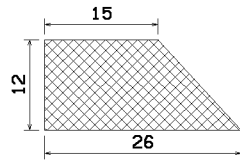

25267
EP/g/ 3141

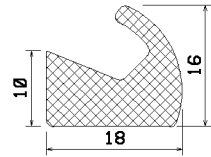

25269
EP/s/ 3172

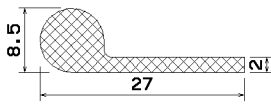

25270
EP/s/ 3173
EP/g/ 3184

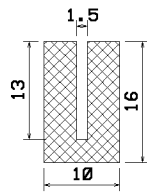

25271
EP/g/ 3183

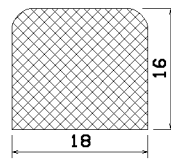

25272
EP/s/ 3206

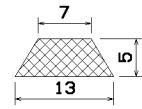

25273
EP/s/ 3228
CR/s/ 3297

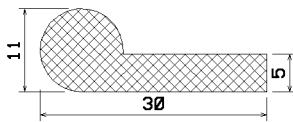

25274
EP/g/ 3231

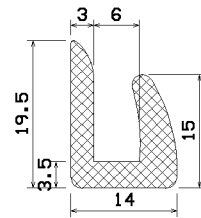

25275
EP/s/ 3237

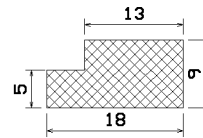

25276
CR/g/ 3255
CR/rb/ 4136

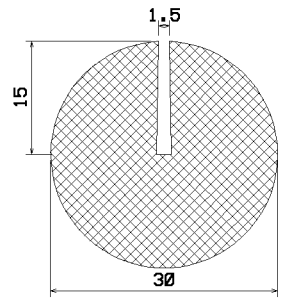

25277
EP/s/ 3263

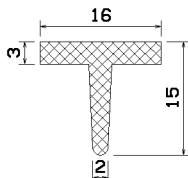

25278
EP/s/ 3275

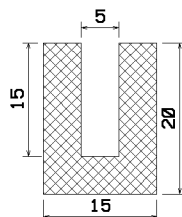

25279
EP/s/ 3283

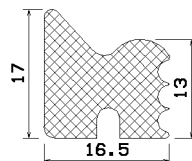

25280
EP/s/ 3296

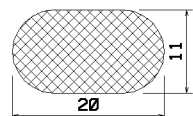

25281
EP/s/ 3298

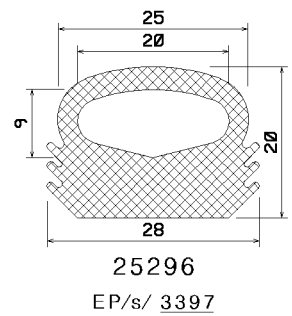
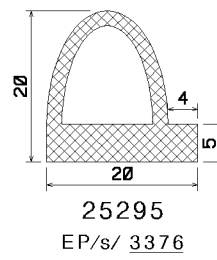
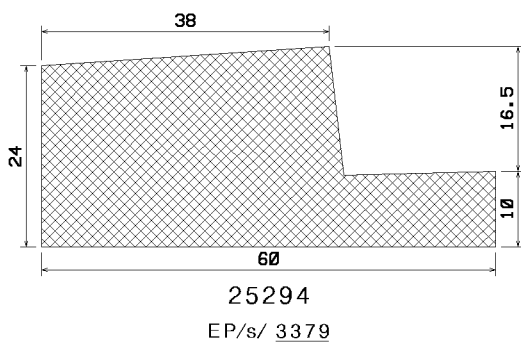
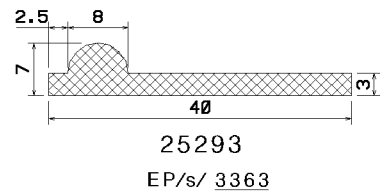
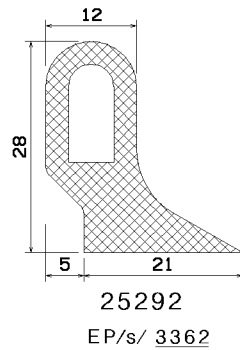
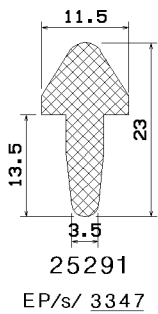
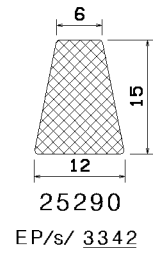
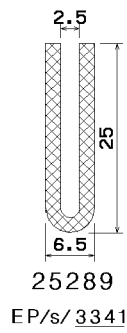
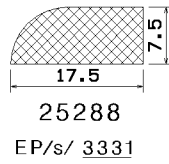
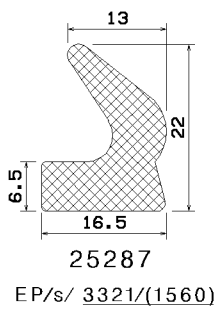
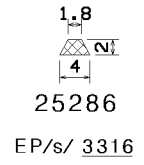
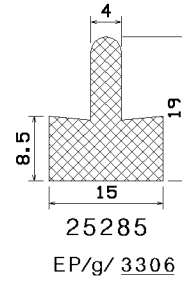
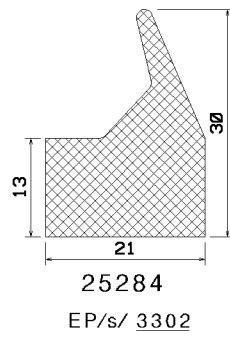
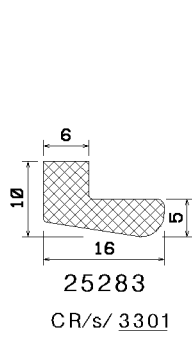

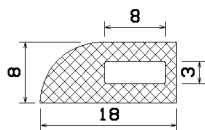

25297

EP/s/ 3427

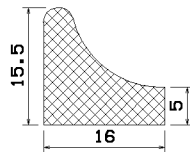

25298

EP/s/ 3419

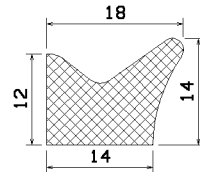

25299

EP/s/ 3445
CR/s/ 4081

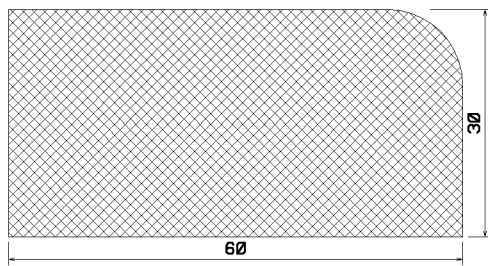

25300

NBR/s/ 3459/(3460)

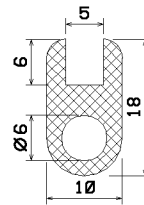

25301

EP/s/ 3469

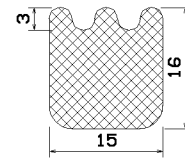

25302

EP/s/ 3476/(3478)

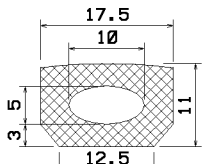

25303

EP/s/ 3477

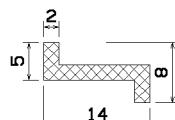

25304

EP/g/ 3494

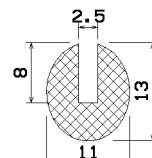

25305

EP/s/ 3482

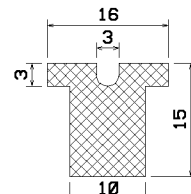

25306

EP/s/ 3505

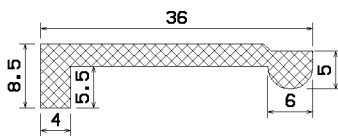

25307

EP/s/ 3520

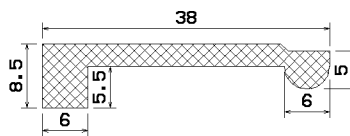

25308

EP/s/ 3521

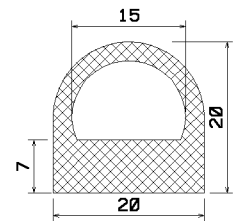

25309

EP/s/ 3510/(4122)

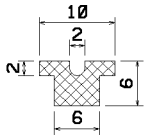

25310

EP/s/ 3516

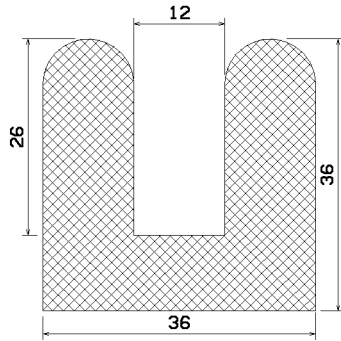

25311

EP/s/ 3523

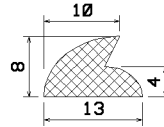

25312

EP/s/ 3526

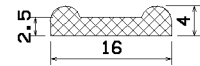

25313

EP/g/ 3527

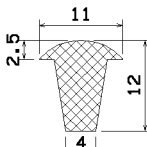

25314

EP/s/ 3564



25315

EP/s/ 3546
EP/g/ 5344
EP060/s/8348

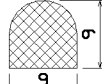

25316

EP/s/ 3548/(0971)
EP/g/ 1026

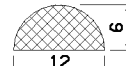

25317

EP/s/ 3553

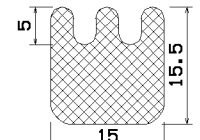

25318

EP/s/ 3560/(3559)

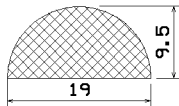

25319

EP/g/ 3555/(1317)

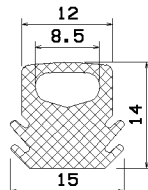

25320

EP/s/ 3581

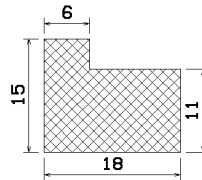

25321

CR/s/ 3589

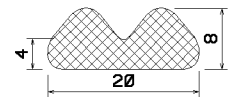

25322

EP/bg/ 3605

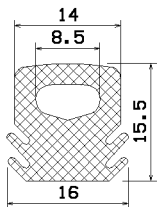

25323

EP/s/ 3597

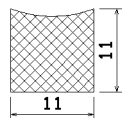

25324

EP/s/ 3606

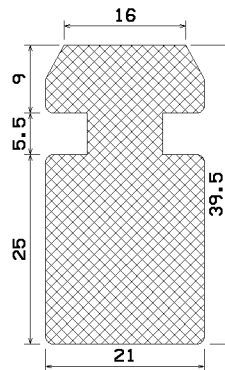

25325

EP/s/ 3612

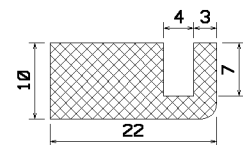

25326

EP/s/ 3622

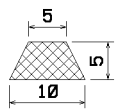

25327
CR/s/ 3623

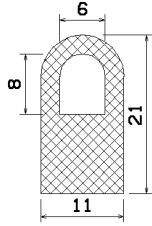

25328
EP/s/ 3630

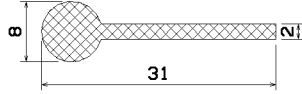

25329
EP/g/ 3652

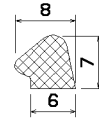

25330
EP/g/ 3651

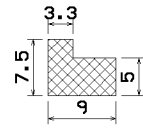

25331
EP/g/ 3650

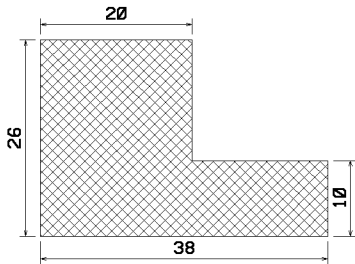

25332
EP/s/ 3656

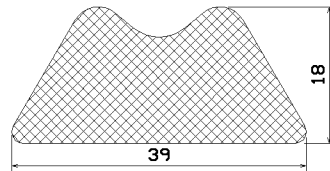

25333
NBR/s/ 3673

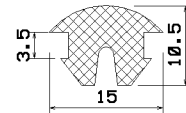

25334
EP/s/ 3676

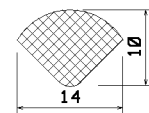

25335
EP/s/ 3690

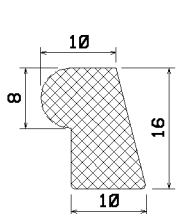

25336
CR/s/ 3715

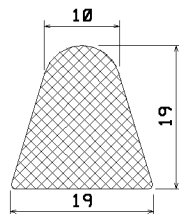

25337
EP/s/ 3719

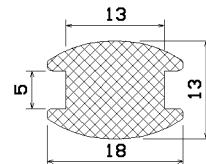

25338
EP/s/ 3727

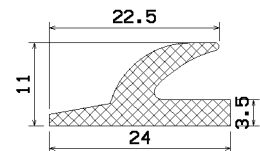

25339
EP/s/ 3729

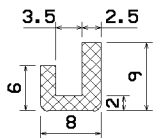

25340
EP/s/ 3736

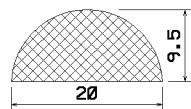

25341
EP/s/ 3735/(4359)
CR/s/ 6450

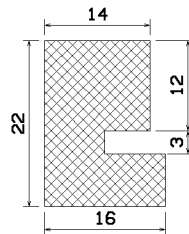

25342
EP/s/ 3745

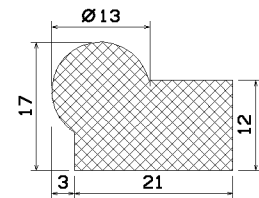

25343
EP/s/ 3755

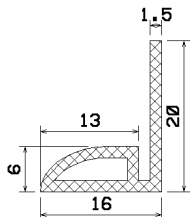

25344
CR/s/ 3757

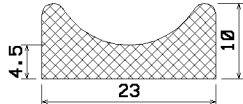

25345
EP/s/ 3759

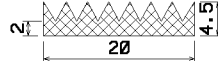

25346
EP/g/ 3778

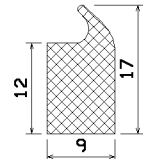

25347
EP/g/ 3779

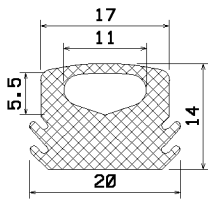

25348
EP/s/ 3785

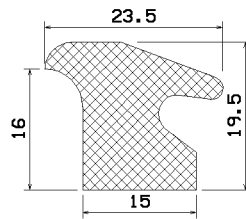

25349
EP/s/ 3792

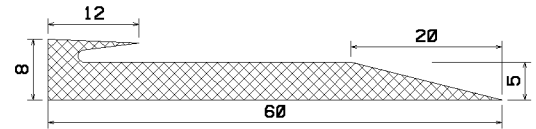

25350
EP/s/ 3790

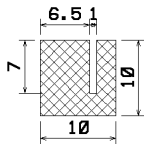

25351
CR/s/ 3837

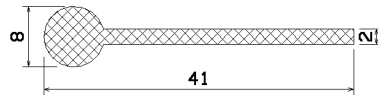

25352
EP/g/ 2998

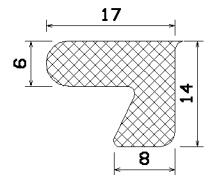

25353
EP/g/ 3813

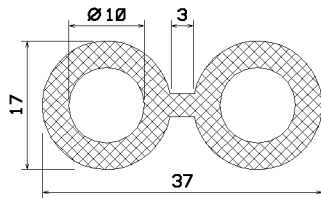

25354
EP/g/ 3836

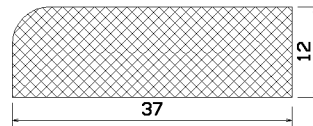

25355
EP/s/ 3835

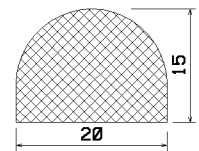

25356
EP/g/ 2605/(2602)
EP/s/ 3851/(3095)

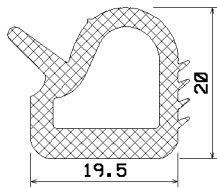

25357

EP/s/ 3857

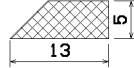

25358

EP/s/ 3850

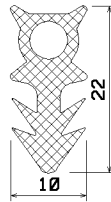

25359

EP/s/ 3854

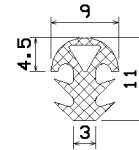

25360

EP/s/ 3879

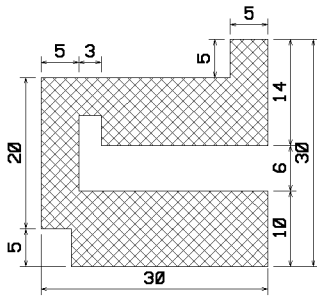

25361

EP/s/ 3865

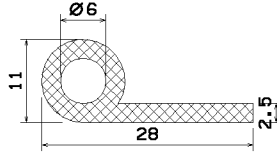

25362

CR-FR/s/3877

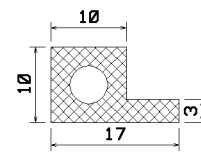

25363

CR-FR/s/ 3872

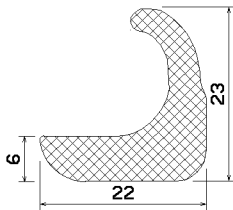

25364

EP/s/ 3871

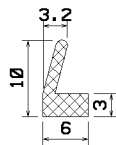

25365

EP/g/ 3897

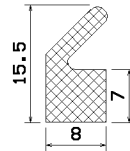

25366

EP/g/ 3898

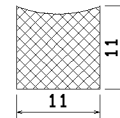

25367

NK/s/ 3894

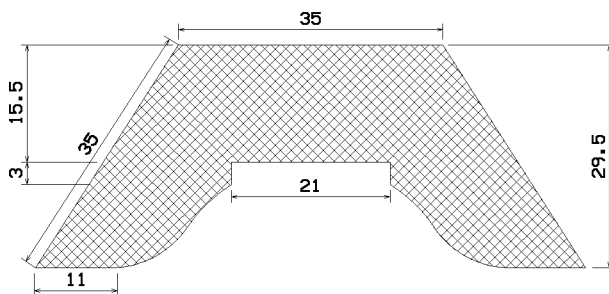

25368

EP/s/ 3896

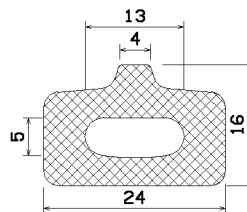

25369

EP/s/ 3902

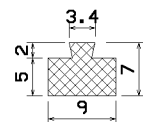

25370

EP/g/ 3913

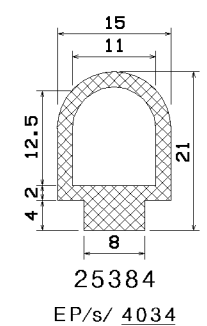
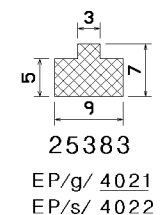
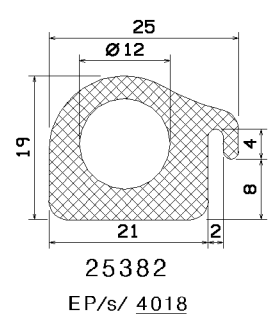
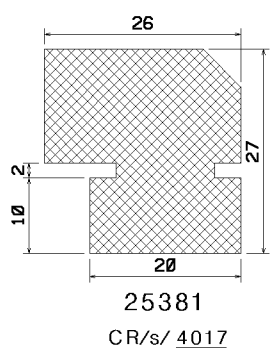
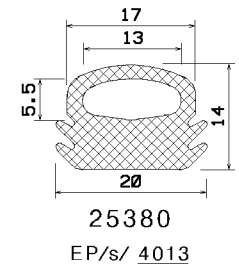
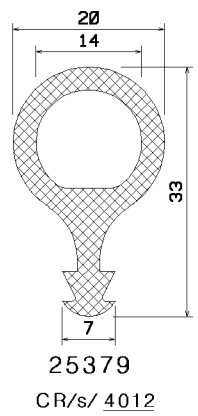
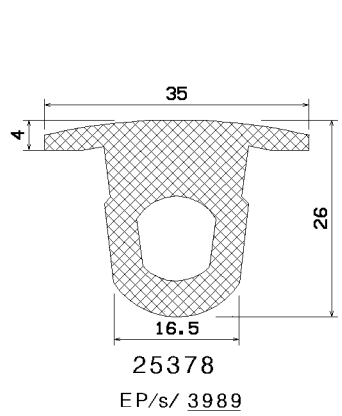
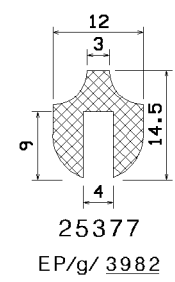
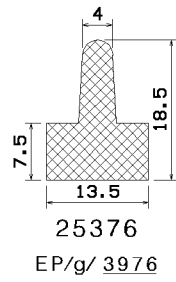
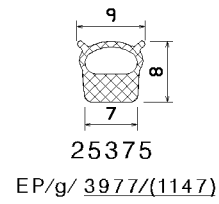
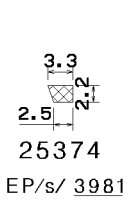
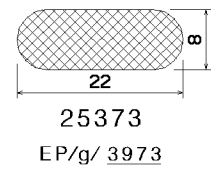
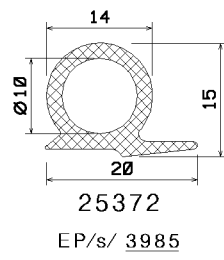
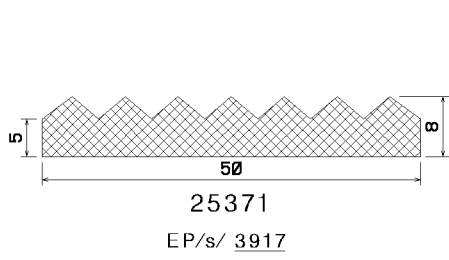

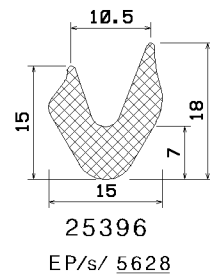
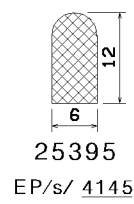
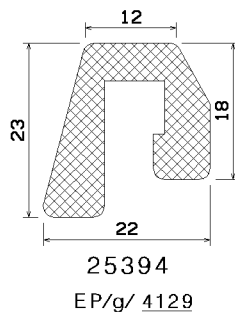
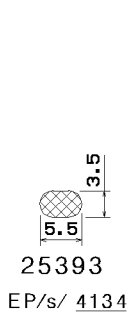
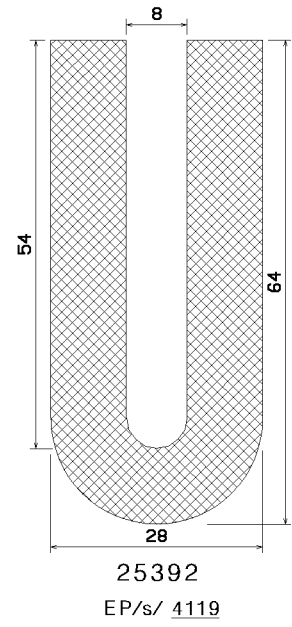
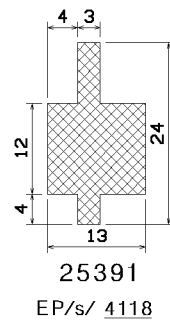
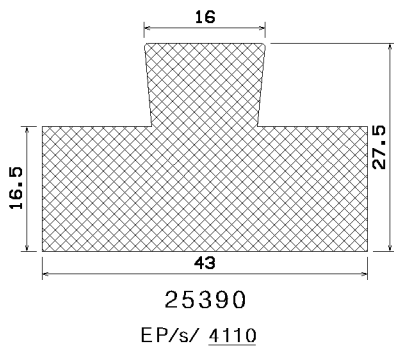
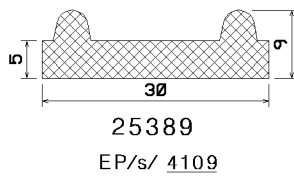
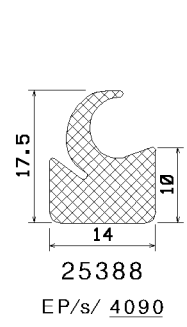
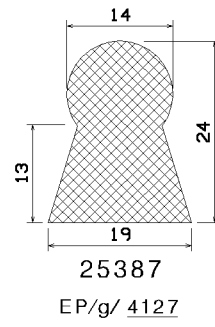
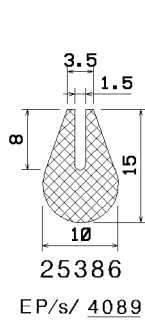
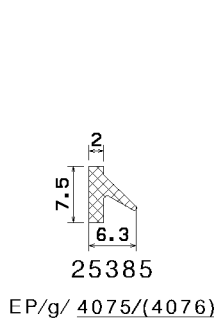

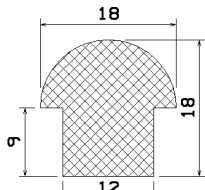

25397
EP/s/ 4144

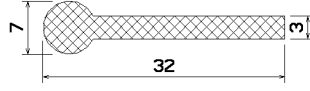

25398
EP/s/ 4161

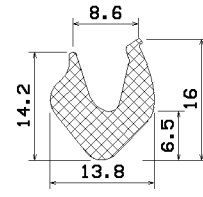

25399
EP/s/ 3096

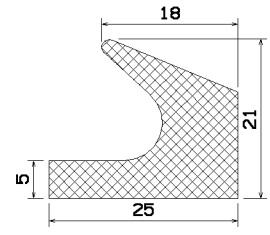

25400
EP/s/ 4178/(4179)

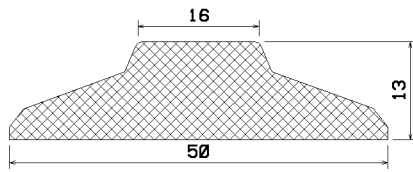

25401
EP/s/ 4177

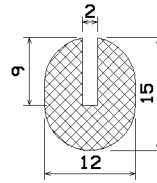

25402
NBR/s/ 4168

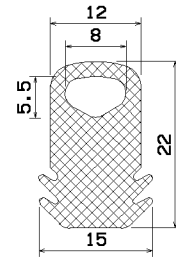

25403
EP/s/ 4176
NBR/g/6064

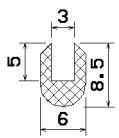

25404
EP/w/ 4187

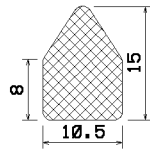

25405
NBR/g/ 4183

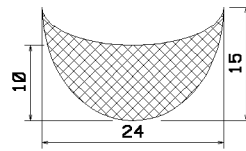

25406
EP/s/ 4195

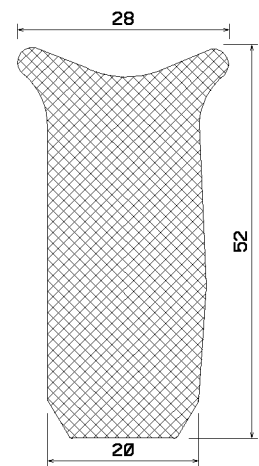

25409
EP/s/ 3765

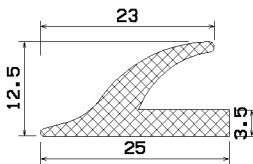

25407
EP/s/ 4194

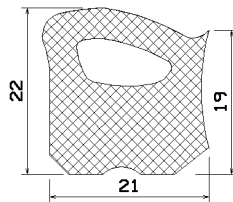

25408
EP/s/ 3428

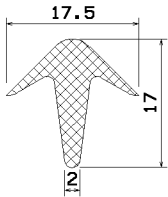

25410

EP/g/ 2255/(2252)



25411

EP/s/ 2368

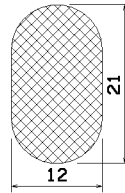

25412

EP/s/ 1030

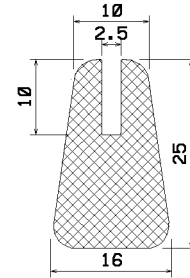

25413

CR/s/ 1031

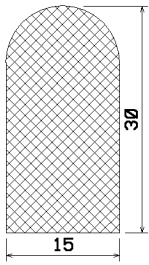

25414

EP/s/ 1032

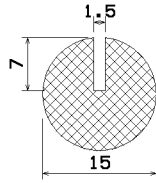

25415

EP/s/ 1050

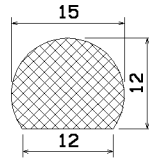

25416

EP/s/ 1046

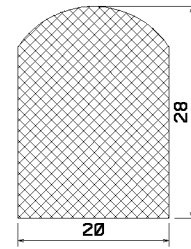

25417

NBR/g/ 1149

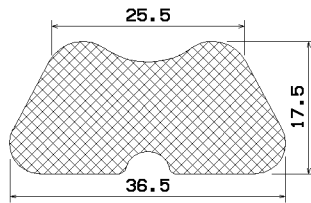

25418

NBR/s/ 0642

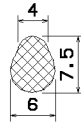

25419

EP/s/ 1124

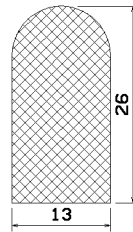

25420

EP/w/ 1155

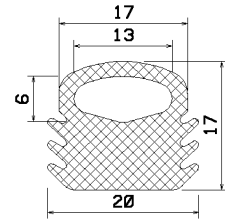

25422

EP/s/ 1490

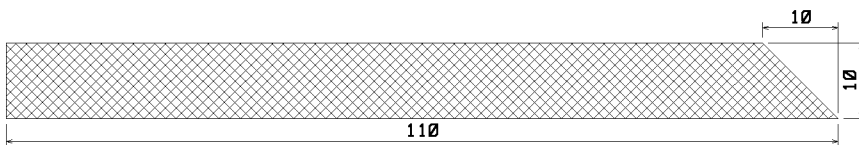

25421

EP/s/ 1372

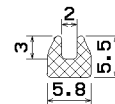

25423

EP/s/ 1385

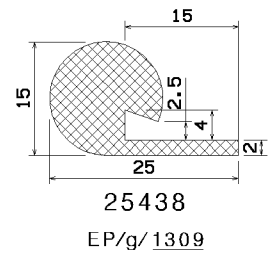
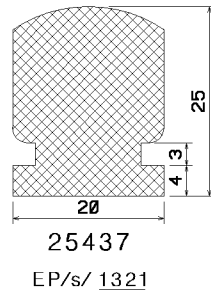
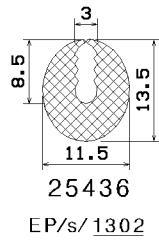
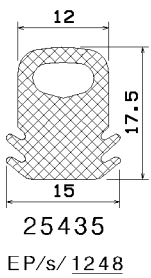
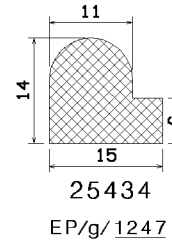
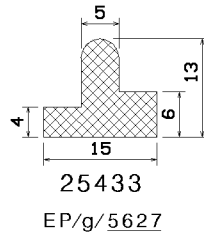
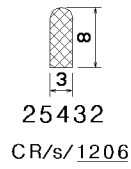
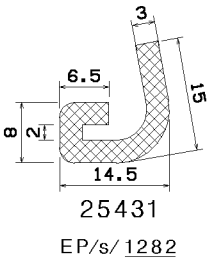
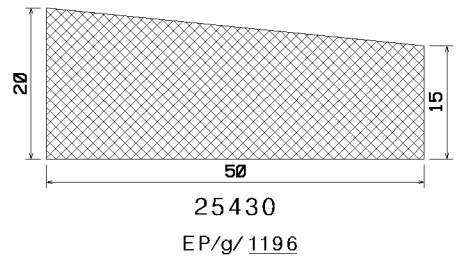
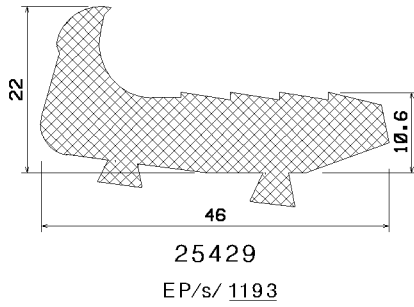
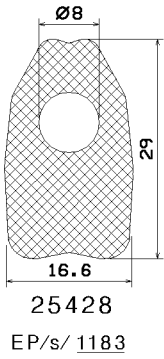
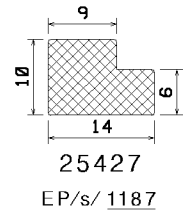
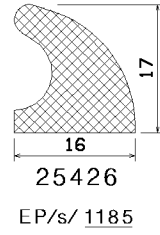
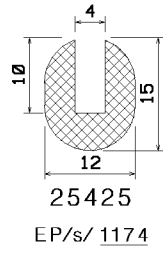
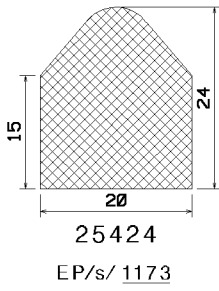

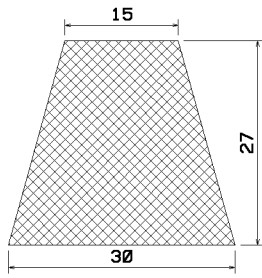

25439
EP/s/ 1298

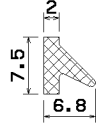

25440
EP/g/ 5626/(1468)



25441
EP/s/ 1474

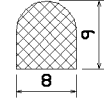

25442
EP/s/ 1470

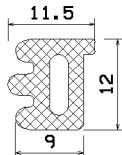

25443
EP/s/ 1460/(1508)

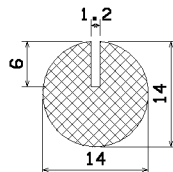

25444
EP/s/ 1860

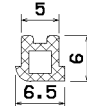

25445
EP/s/ 1657

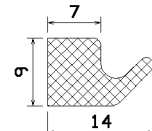

25446
EP/s/ 1868

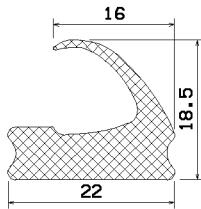

25447
EP/s/ 1869

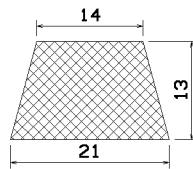

25448
NBR/g/ 1430

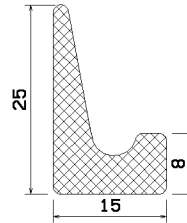

25449
EP/s/ 1915

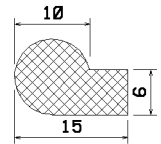

25450
NBR/g/ 1985

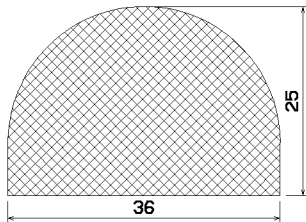

25451
EP/s/ 2063



25452
EP/s/ 2970

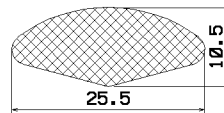

25453
CR/s/ 3225

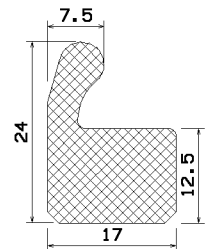

25454
CR/s/ 4283

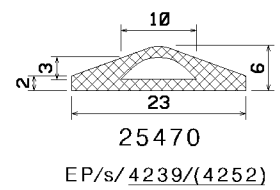
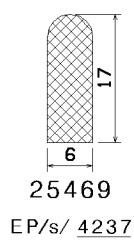
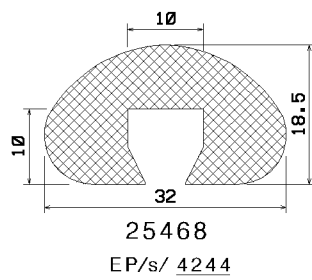
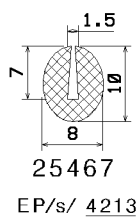
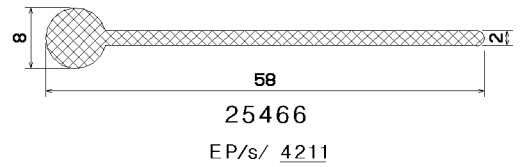
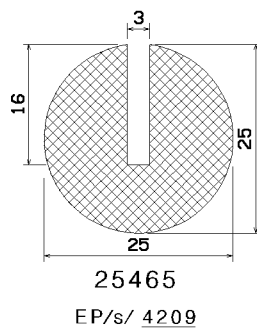
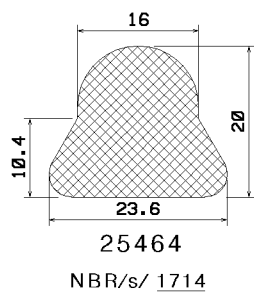
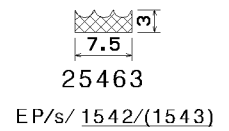
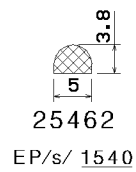
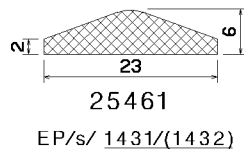
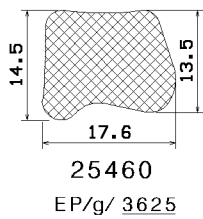
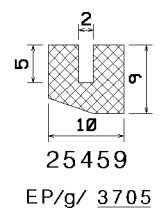
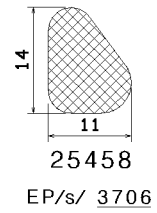
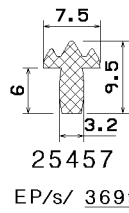
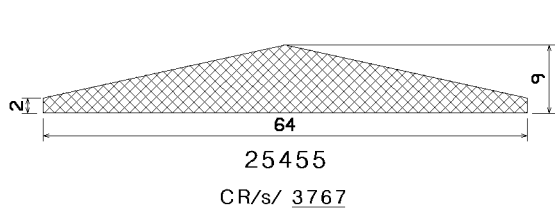

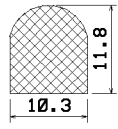

25471
EP/s/4328

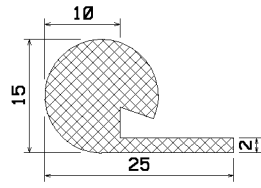

25472
EP/g/4267

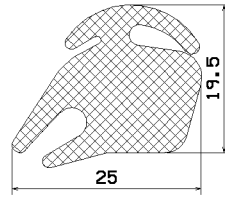

25473
EP/s/4282

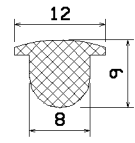

25474
EP/s/4293

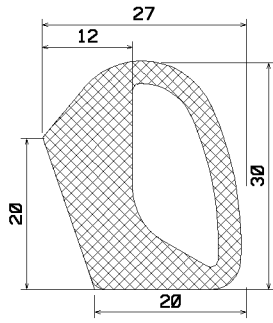

25475
EP/s/4292

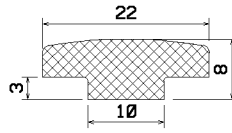

25476
EP/s/4306

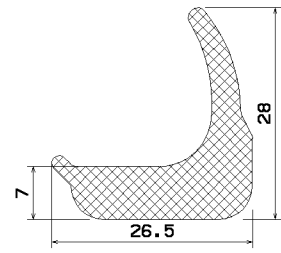

25477
EP/g/4305
EP/s/4364

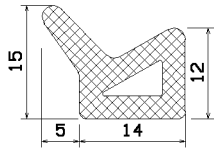

25480
CR/s/4344

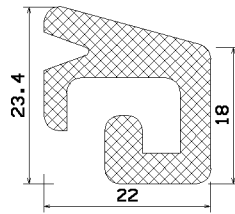

25481
EP/s/4043

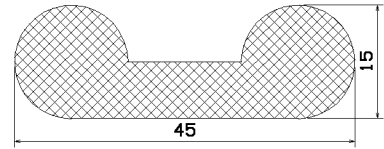

25482
EP/s/4369

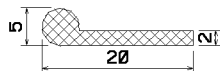

25483
EP/s/4378/(4379)

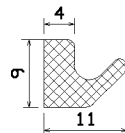

25484
EP/s/4381

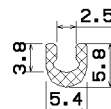

25485
EP/s/4387

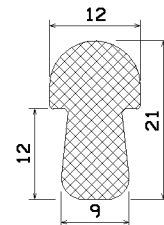

25486
EP/s/4428

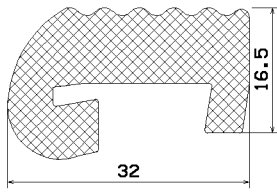

25487
EP/s/4497

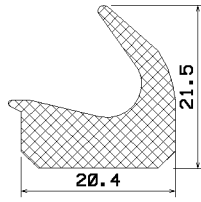

25488
EP/s/4489

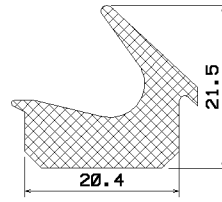

25489
EP/s/4490

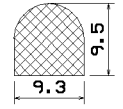

25490
EP/s/4501

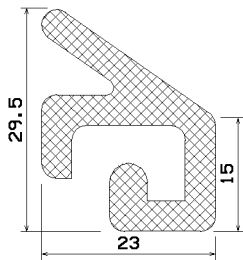

25491
EP/s/4506

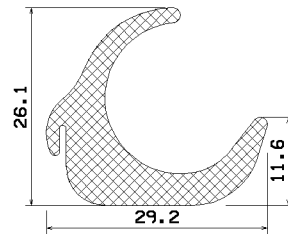

25492
EP/s/4513

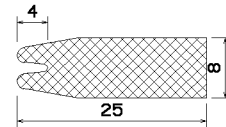

25493
EP/s/4511

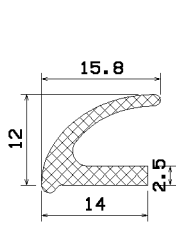

25494
EP/s/4523

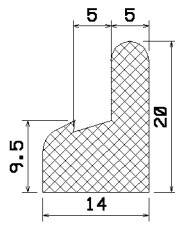

25495
EP/s/4605

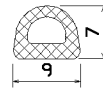

25496
EP/s/4563

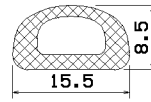

25497
EP/s/4564

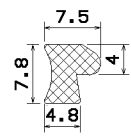

25498
EP/s/4574

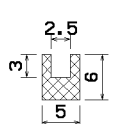

25499
EP/s/5001

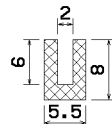

25500
EP/s/5002

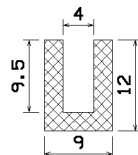

25501
EP/s/5003

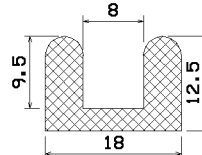

25502
EP/s/5004

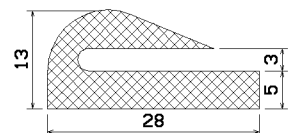

25503
EP/s/5005

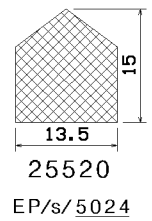
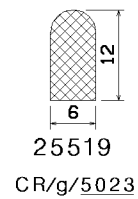
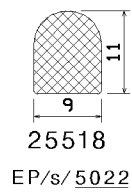
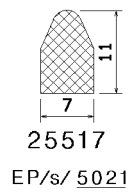
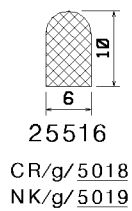
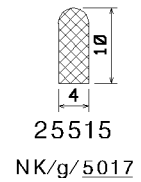
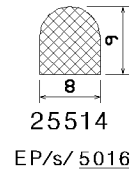
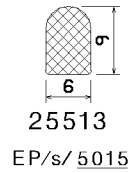
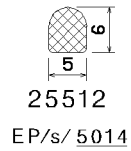
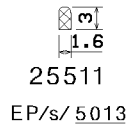
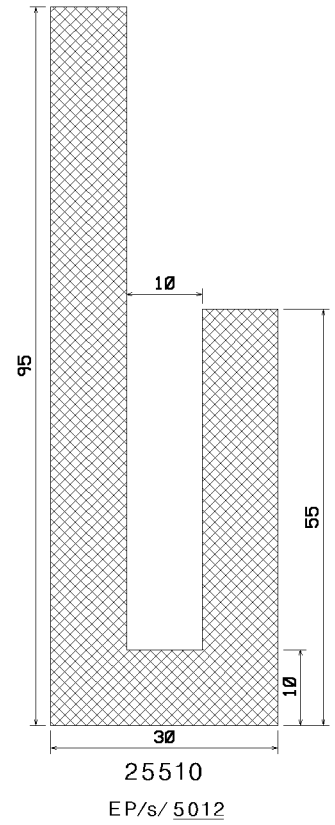
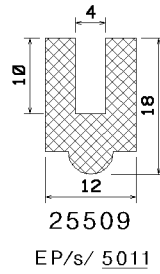
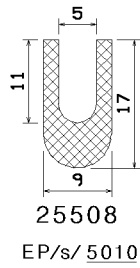
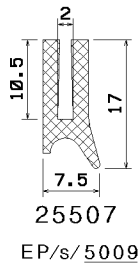
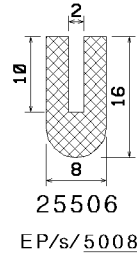
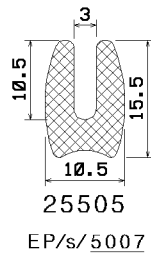
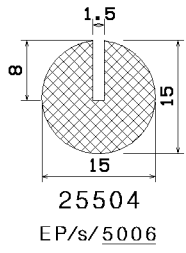

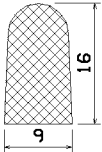

25521

EP/s/5025

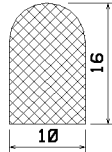

25522

EP/s/5026

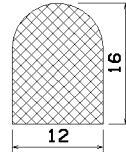

25523

EP/s/5020

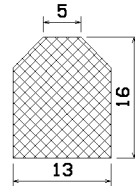

25524

EP/s/5027

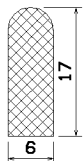

25525

EP/s/5028

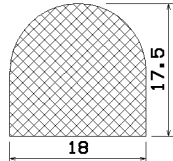

25526

EP/s/5029

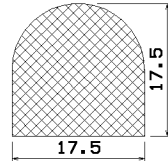

25527

CR/s/5030

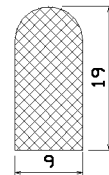

25528

EP/s/5031

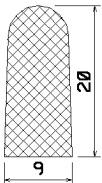

25529

EP/s/5032

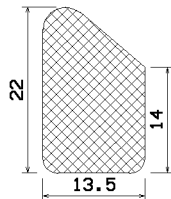

25530

EP/s/5033

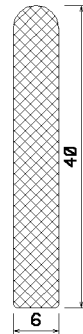

25531

EP/s/5034



25532

NK/g/5035

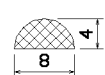

25533

EP/g/5036

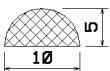

25534

NK/s/5037

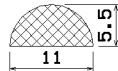

25535

NK/g/5038
EP/s/5039

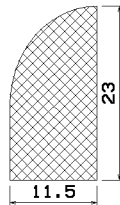

25536

NK/s/5040

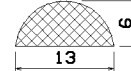

25537

EP/s/5041

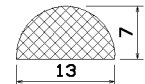

25538

NK/g/5042

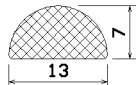

25539
EP/s/5043

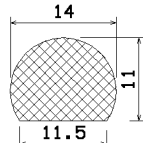

25540
EP/s/5044

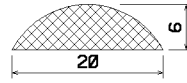

25541
EP/s/5045

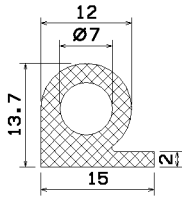

25543
EP/s/5047

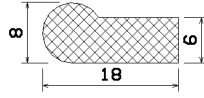

25544
EP/g/5048
CR/s/5049

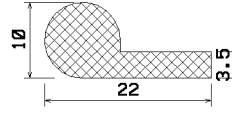

25545
EP/s/5050

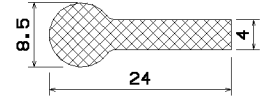

25546
EP/s/5051

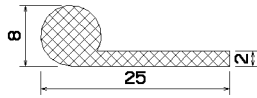

25547
NK/g/5052

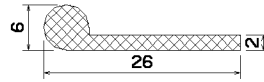

25548
NK/g/5053

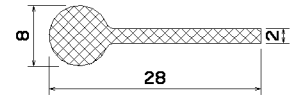

25549
EP/s/5054

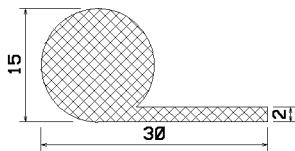

25550
NK/g/5055

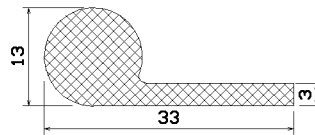

25551
CR/s/5056

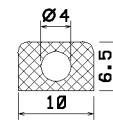

25552
EP/s/5057

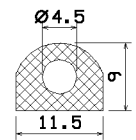

25553
EP/s/5058

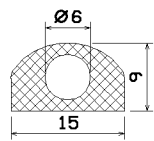

25554
EP/s/5059

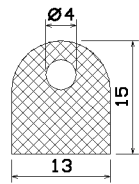

25555
EP/s/5060

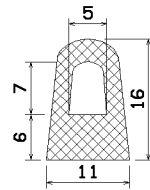

25556
EP/s/5061

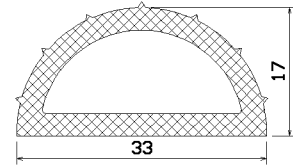

25557
EP/s/5062

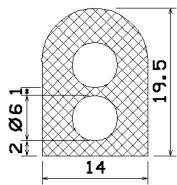

25558
EP/s/5063

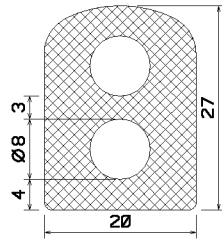

25559
EP/s/5064

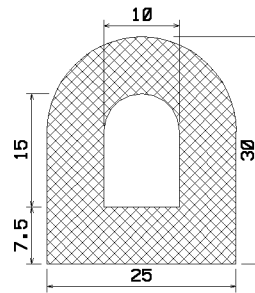

25560
EP/s/3227

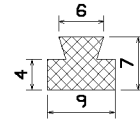

25561
EP/g/5066

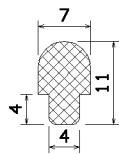

25562
EP/s/5067

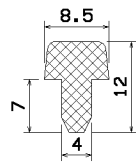

25563
EP/s/5068

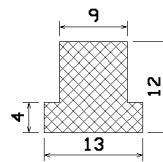

25564
EP/s/5069

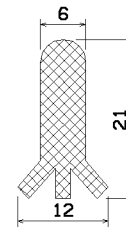

25565
NK/az/5070

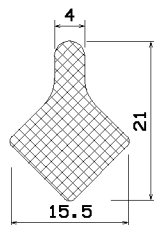

25566
EP/s/5071

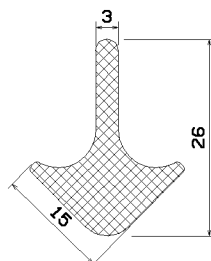

25567
CR/g/5072

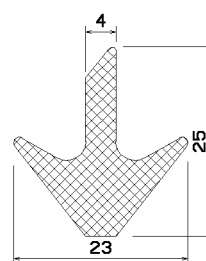

25568
EP/s/5073

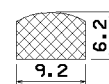

25569
EP/s/5074

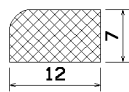

25570
EP/g/5075

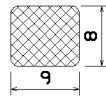

25571
EP/s/5076

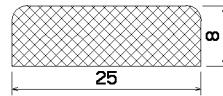

25572
NK/g/5077

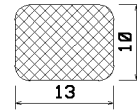

25573
EP/s/5078

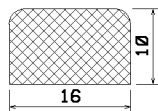

25574
NK/g/5079

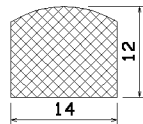

25575
EP/s/5080

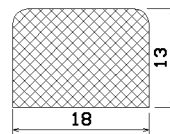

25576
NK/g/5081

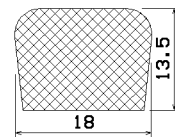

25577
NK/s/5082

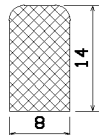

25578
NK/g/5083

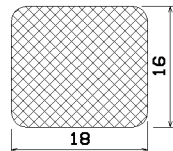

25579
EP/s/5084

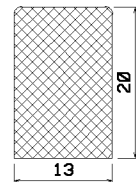

25580
NK/g/5085

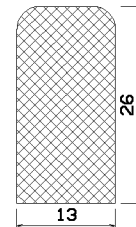

25581
NK/g/5086

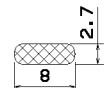

25582
EP/s/5087



25583
EP/s/5088

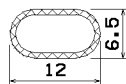

25584
EP/s/5089

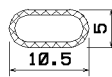

25585
EP/s/5090

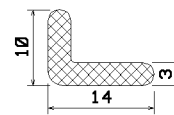

25586
CR/s/5091

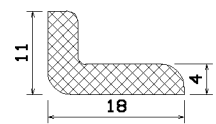

25587
CR/s/5092

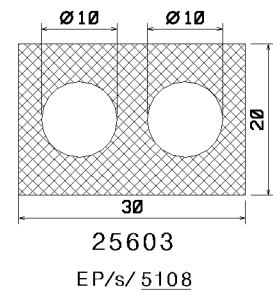
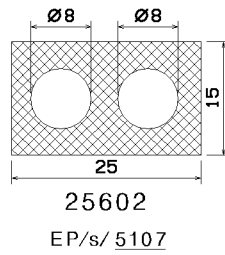
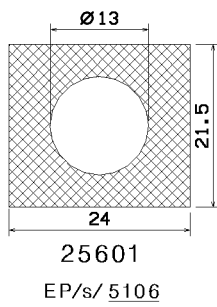
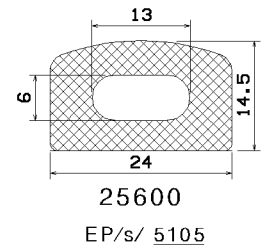
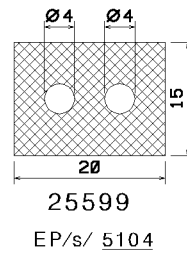
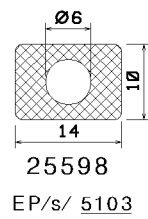
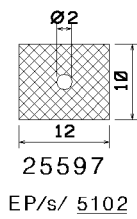
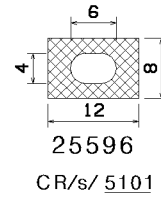
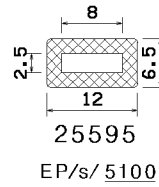
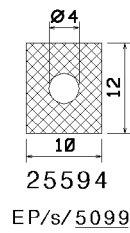
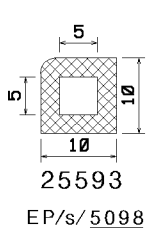
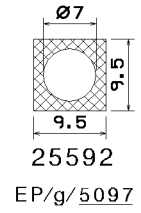
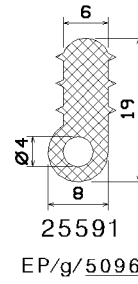
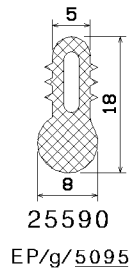
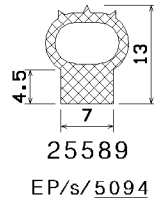
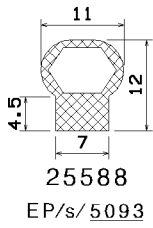

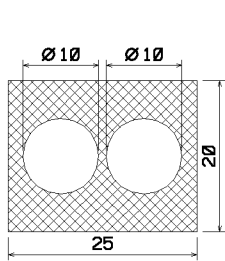

25604
EP/s/ 5109

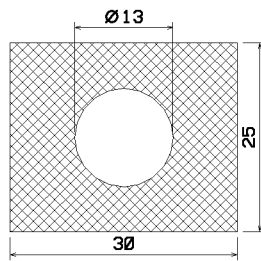

25605
EP/s/ 5110



25606
EP/s/ 5111

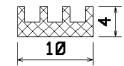

25607
EP/s/ 5112

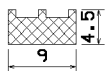

25608
EP/s/ 5113

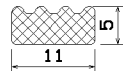

25609
EP/s/ 5114

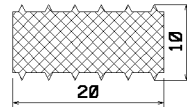

25610
EP/s/ 5115

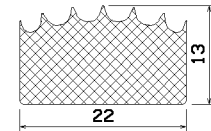

25611
EP/s/ 5116

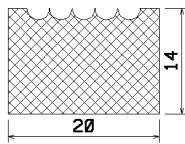

25612
CR/g/ 5117

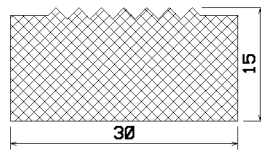

25613
CR/g/ 5118

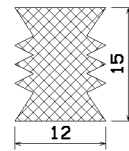

25614
EP/s/ 5119

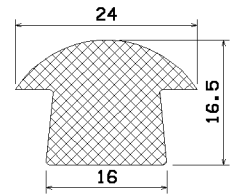

25615
EP/s/ 5120

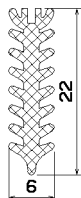

25616
EP/s/ 5121

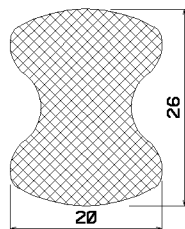

25617
EP/s/ 5122

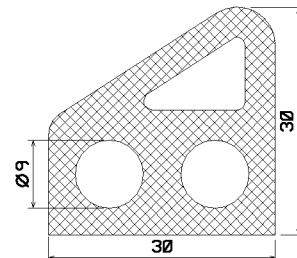

25618
EP/s/ 5123

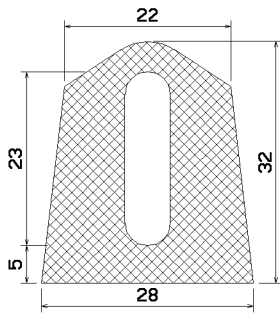

25619
EP/s/ 5124

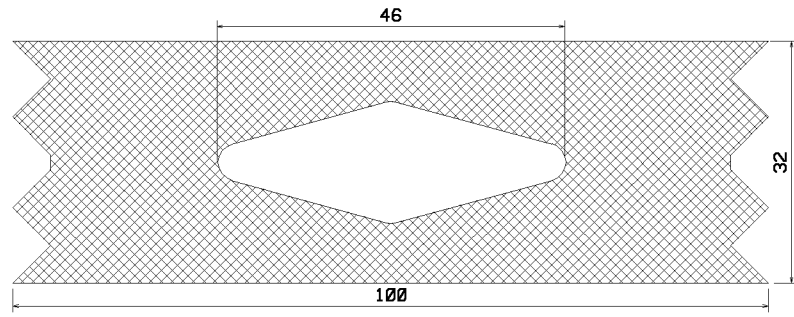

25620
EP/s/ 5125

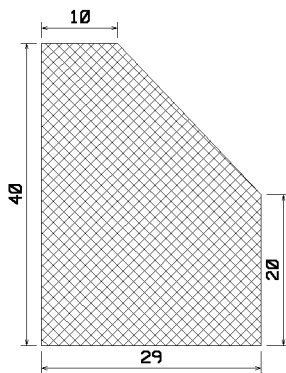

25621
EP/s/ 5126

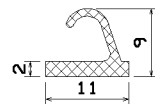

25622
EP/s/ 5127

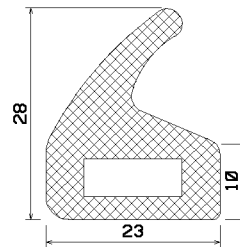

25623
CR/s/ 5128

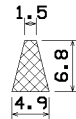

25624
EP/s/ 5129

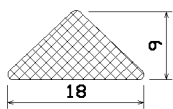

25625
NK/g/ 5130

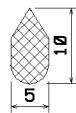

25626
EP/s/ 5131

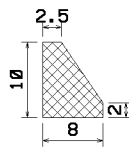

25627
EP/s/ 5132

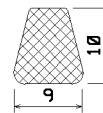

25628
EP/s/ 5133

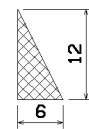

25629
EP/s/ 5134

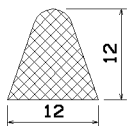

25630
EP/s/ 5135

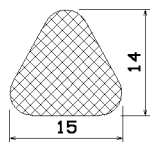

25631
EP/s/ 5136

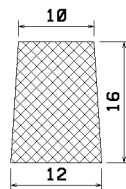

25632
CR/s/ 5137

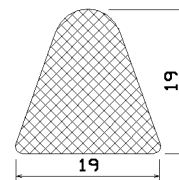

25633
EP/s/ 2251

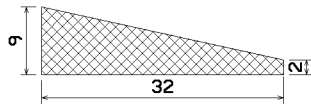

25634
EP/s/ 5139

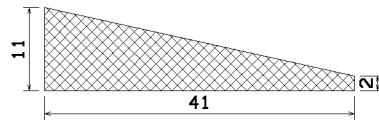

25635
EP/s/ 5140

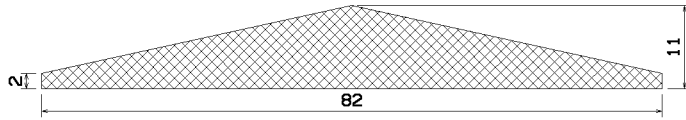

25636
EP/s/ 5141

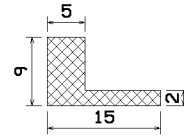

25637
EP/s/ 4588

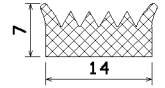

25638
EP/w/ 4586

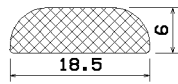

25639
EP/g/4601/(4602)

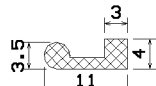

25640
EP/g/ 4610

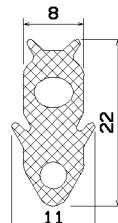

25641
EP/s/ 4663

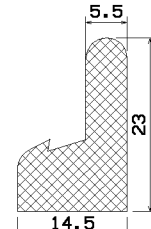

25642
EP/s/ 4689

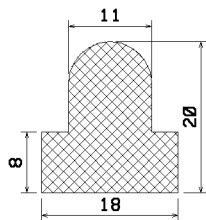

25643
CR/s/ 4679

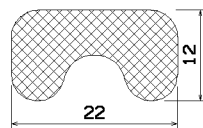

25644
EP/w/ 4673

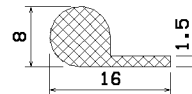

25645
EP/g/ 4674

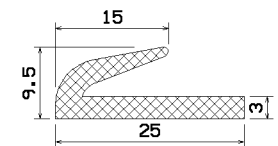

25646
CR/s/ 4683/(4684)

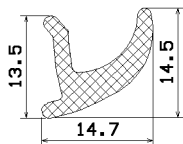

25647
EP/s/ 0472

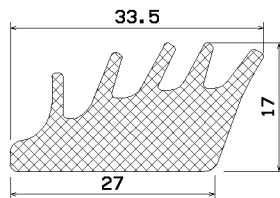

25648
EP/s/ 4736

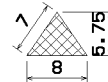

25649
EP/s/ 4714

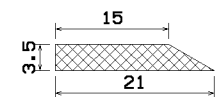

25650
EP/s/ 4725

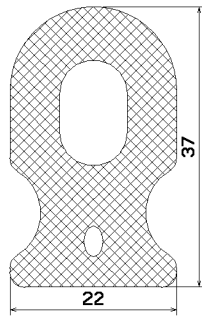

25651
EP/s/ 4740

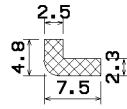

25652
EP/g/ 4742

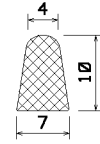

25653
EP/g/ 4750

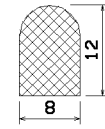

25654
EP/s/ 4754

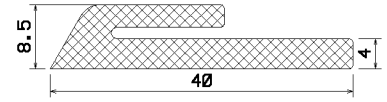

25655
EP/g/ 4757

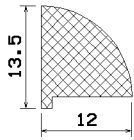

25656
EP/s/ 4776

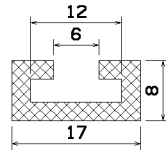

25657
EP/s/ 4786

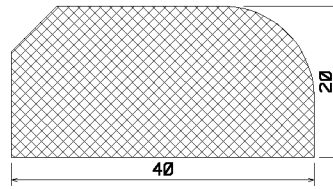

25658
EP/s/ 4798

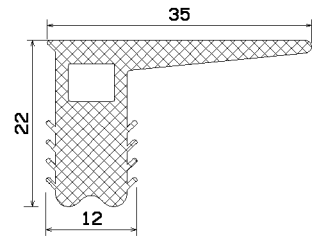

25659
CR/s/ 4835

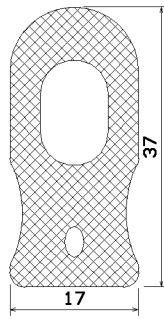

25660
EP/s/ 4796

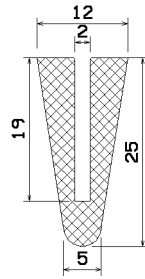

25661
EP/s/ 4806

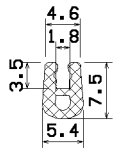

25662
EP/s/ 4830

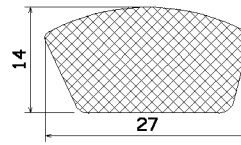

25663
EP/s/ 4831

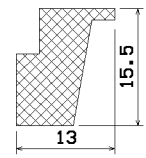

25664
EP/s/ 4832

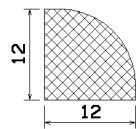

25666
EP/s/ 4881

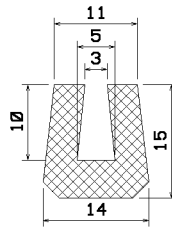

25667
EP/s/ 4882

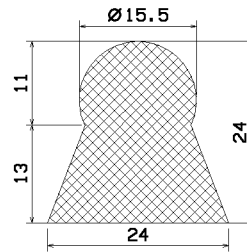

25668
EP/g/ 4884

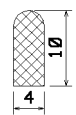

25669
EP/g/ 4878

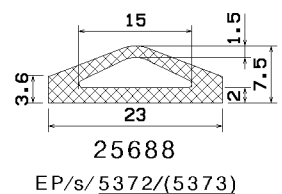
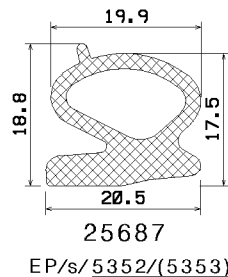
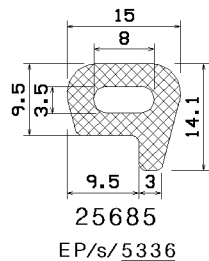
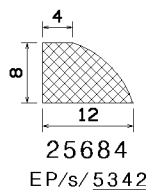
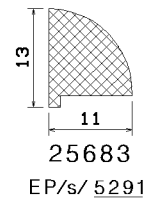
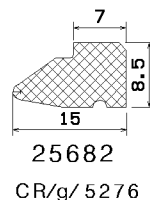
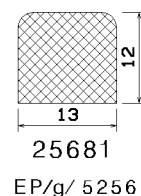
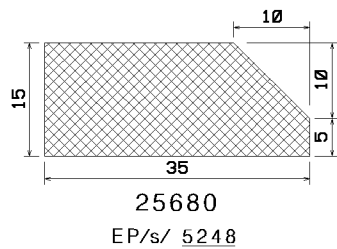
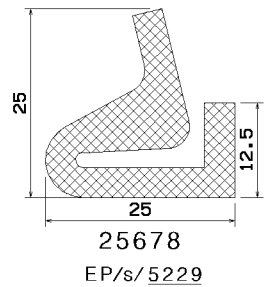
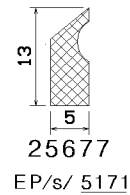
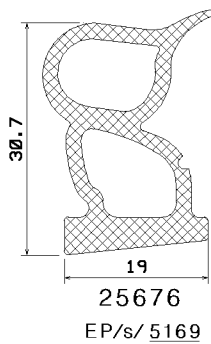
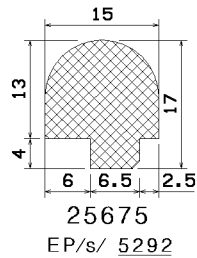
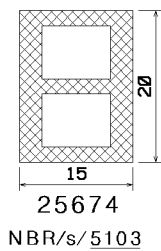
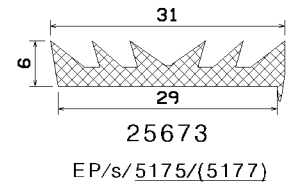
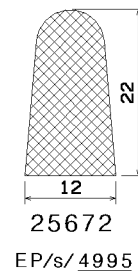
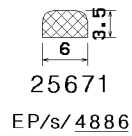
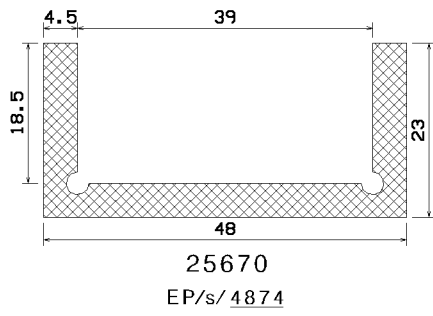

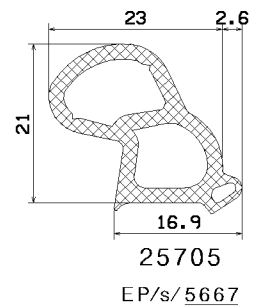
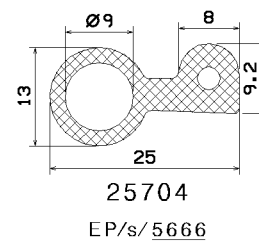
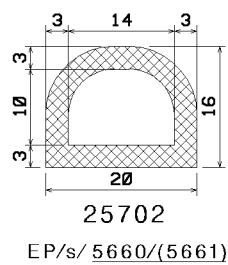
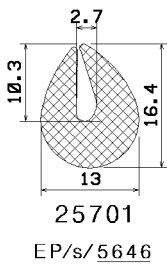
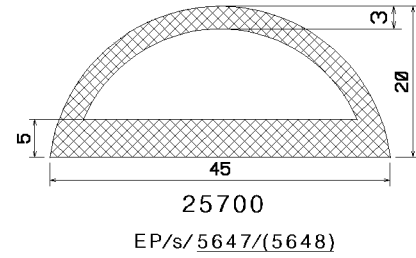
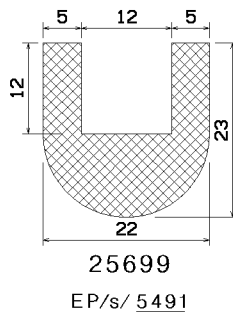
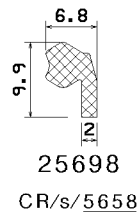
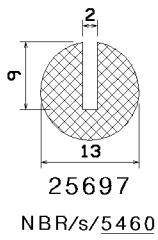
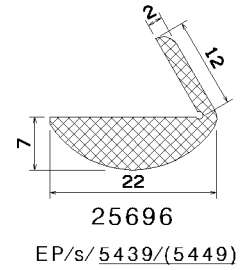
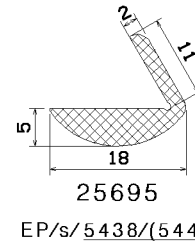
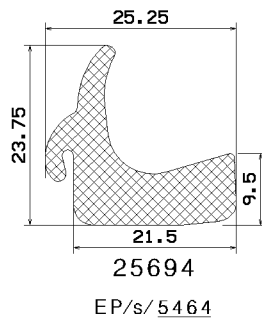
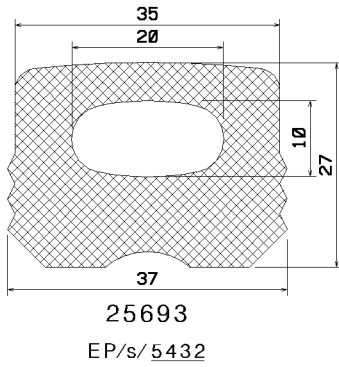
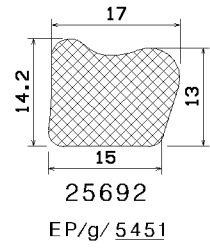
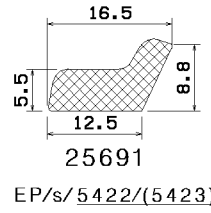
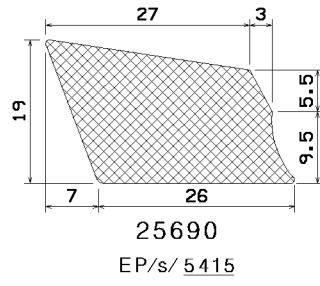
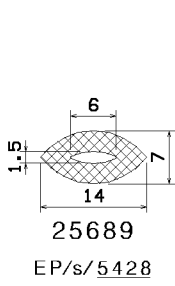

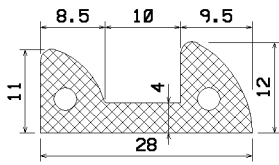

25706
EP/s/5672

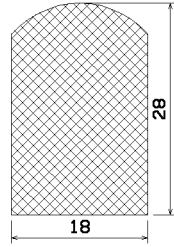

25707
NBR/hg/5879

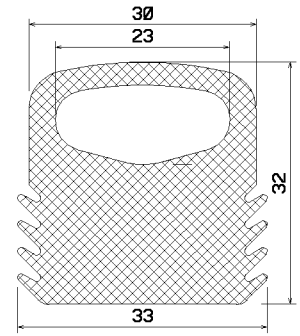

25709
EP/s/5744

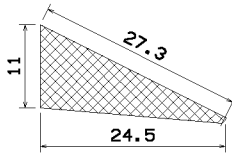

25710
NBR/s/5728

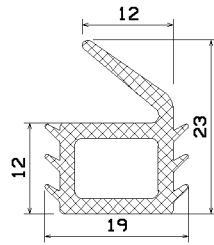

25711
EP/s/5786

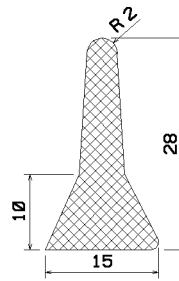

25712
EP/g/5837

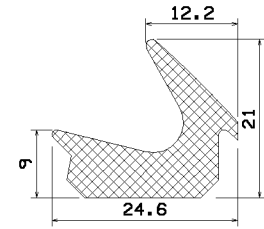

25713
EP/s/5838

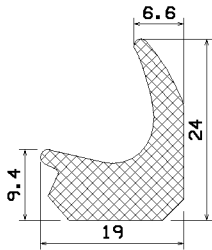

25714
EP/s/5839

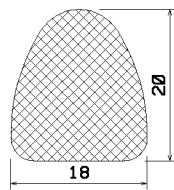

25715
FPM/s/5889

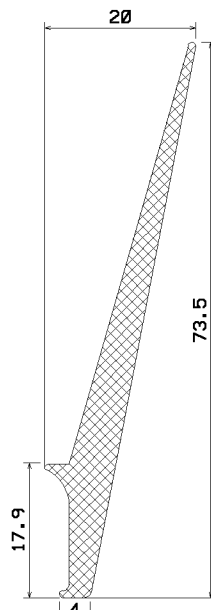

25719
EP/s/5877

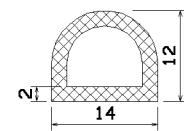

25716
EP/s/5869/(5870)

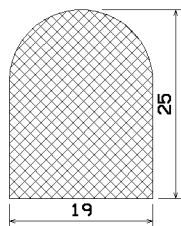

25717
EP/s/5871

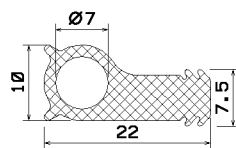

25718
EP/s/5873

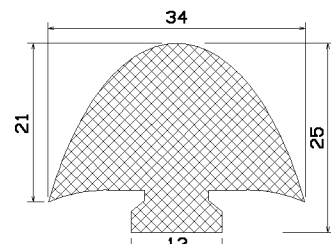

25720
EP/g/5939

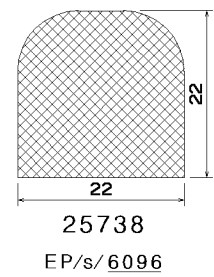
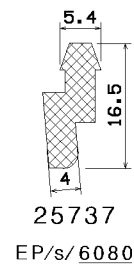
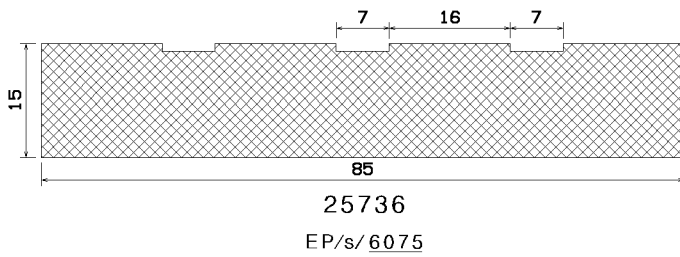
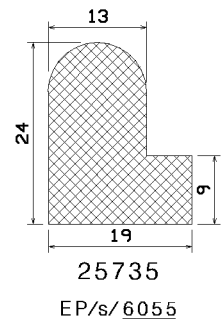
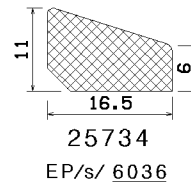
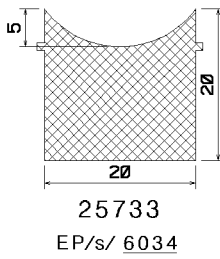
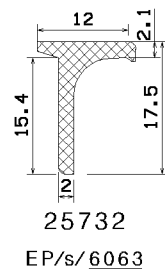
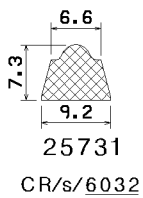
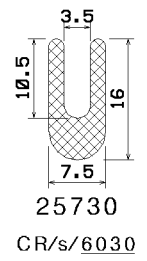
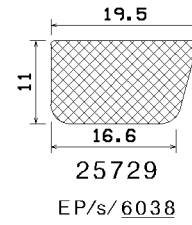
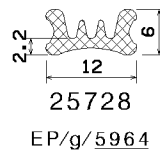
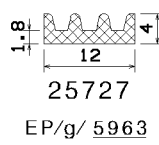
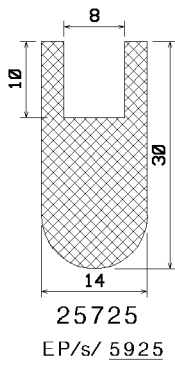
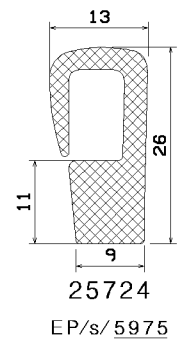
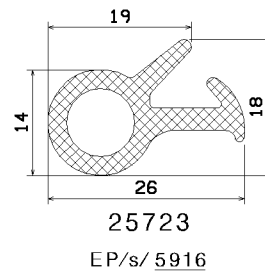
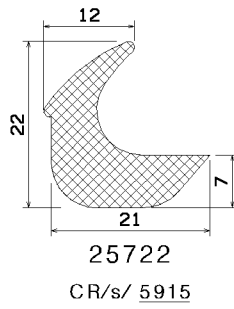
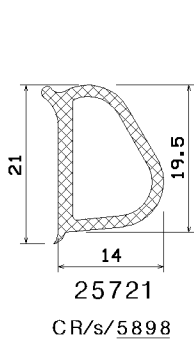

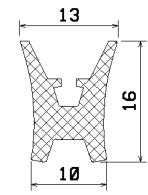

25739
EP/s/ 6094

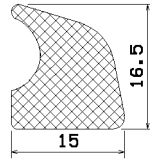

25740
EP/s/ 6124

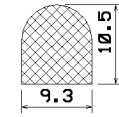

25741
EP/s/ 6110

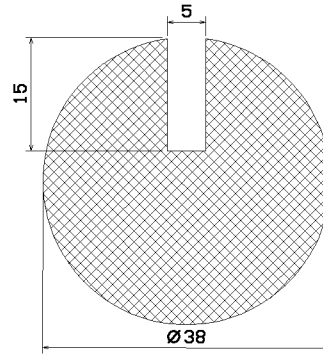

25742
EP/s/ 6150

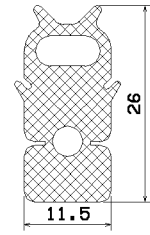

25743
EP/s/ 6158

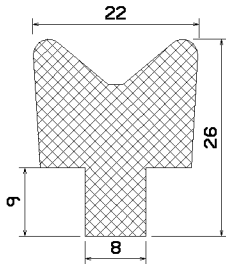

25744
EP/s/ 6167

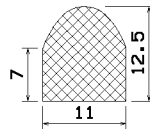

25745
EP/s/ 6165

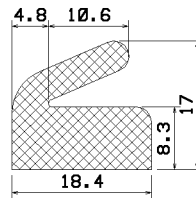

25746
CR/s/ 6194

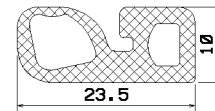

25747
EP/s/ 6203

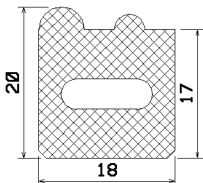

25748
EP/s/ 6193

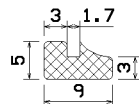

25749
EP/s/ 6198

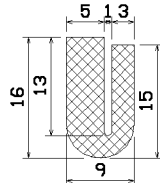

25750
EP/s/ 6465

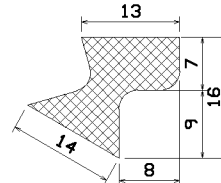

25751
EP/s/ 6466

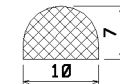

25752
CR/s/ 6476

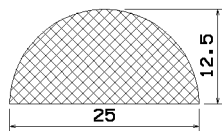

25753
CR/s/ 6477

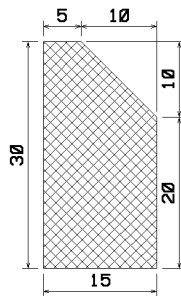

25754
EP/s/ 6537

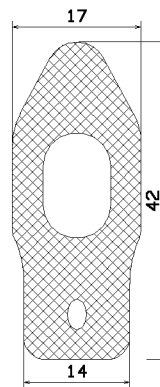

25756
EP/s/ 6842

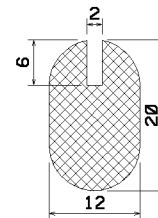

25757
FPM/s/6899

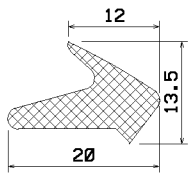

25758
EP/s/ 6857

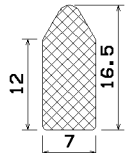

25759
EP/s/ 6861

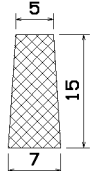

25760
NBR/s/ 6867

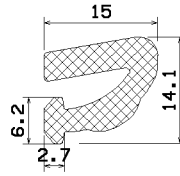

25761
EP/s/ 6880

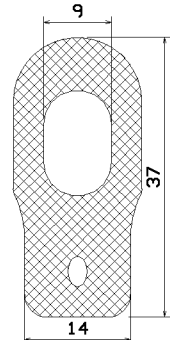

25763
EP/s/ 6894

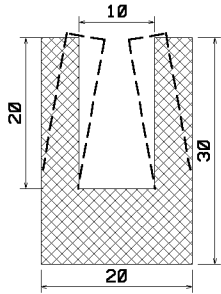

25764
EP/s/ 6924

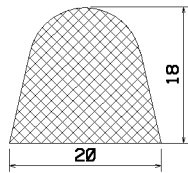

25765
EP/s/ 6985

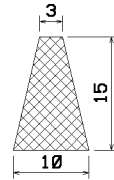

25766
EP/g/ 6949

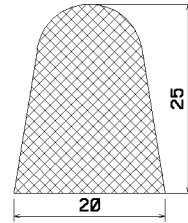

25767
EP/s/ 6990

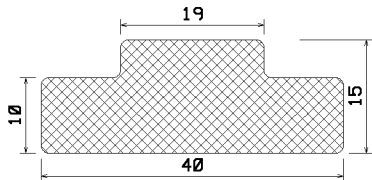

25768
CR/s/ 6991

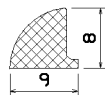

25769
EP/s/ 7027

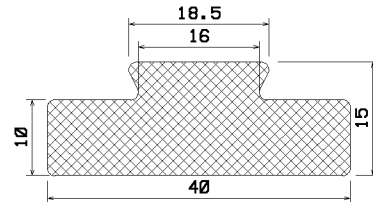

25771
CR/s/ 7121/(7122)

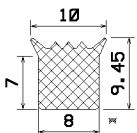

25772
EP/g/ 7129

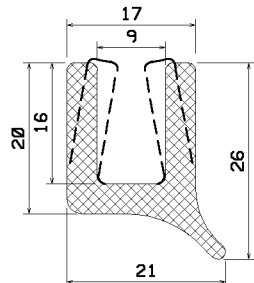

25773
EP/s/ 7135

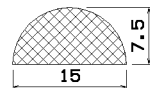

25776
NBR/g/ 7169

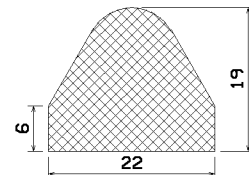

25777
EP/s/ 7171

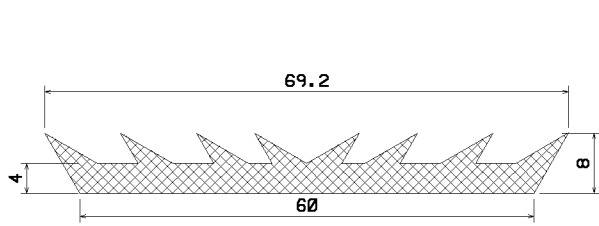

25778
EP/s/ 7214

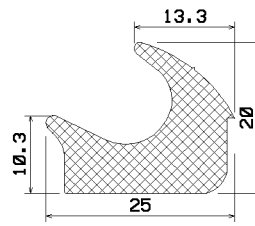

25779
EP/s/ 7233

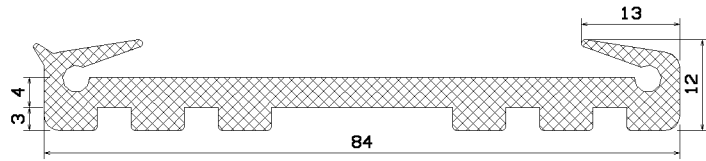

25780
EP/s/ 7247

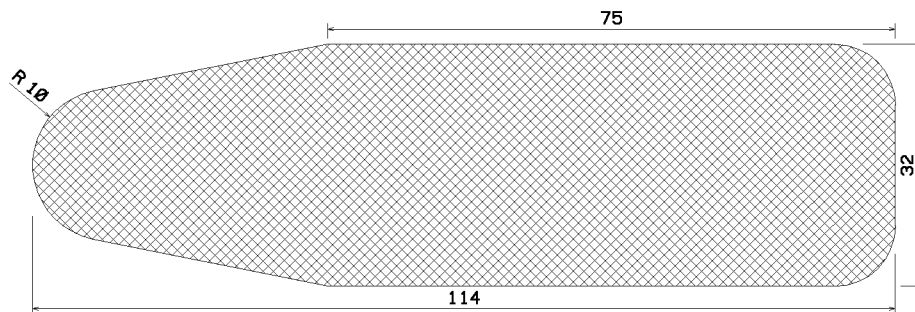

25781
EP/s/ 7274

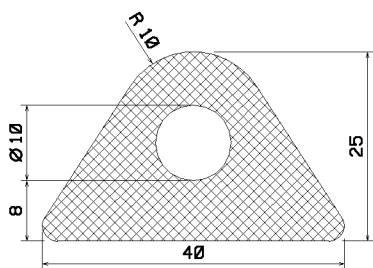

25782
EP/s/ 7341

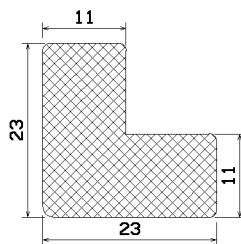

25783
EP/s/ 7555

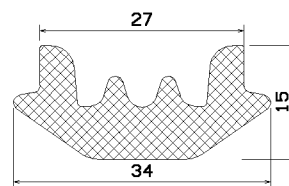

25784
EP/s/ 7626

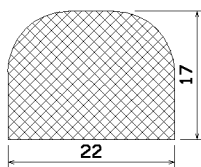

25785
EP/s/ 7729



25786
CR/s/ 7819

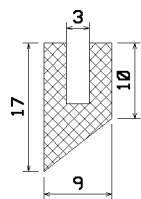

25787
EP/s/ 7918

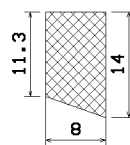

25788
EP/s/ 7931

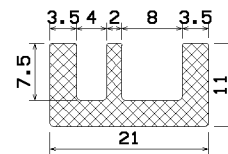

25789
EP/s/ 7930

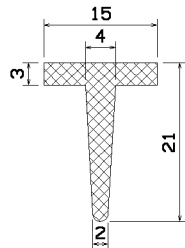

25791
EP/s/ 7983

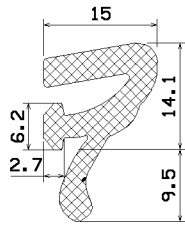

25792
EP/s/ 8062

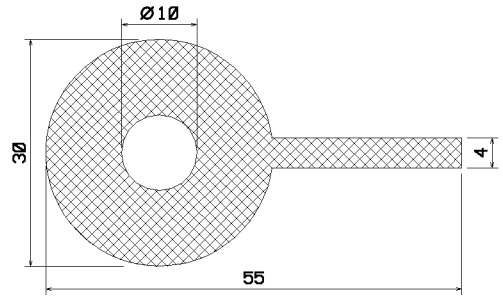

25793
NBR/hg/ 8069

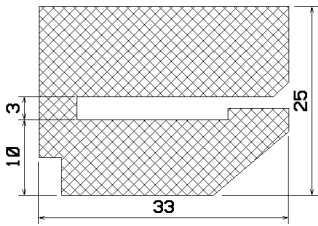

25794
EP/s/ 8111

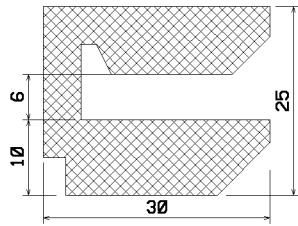

25795
EP/s/ 8110

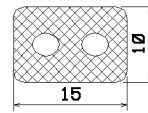

25796
EP/s/ 8147/(8158)

25797
(FT)

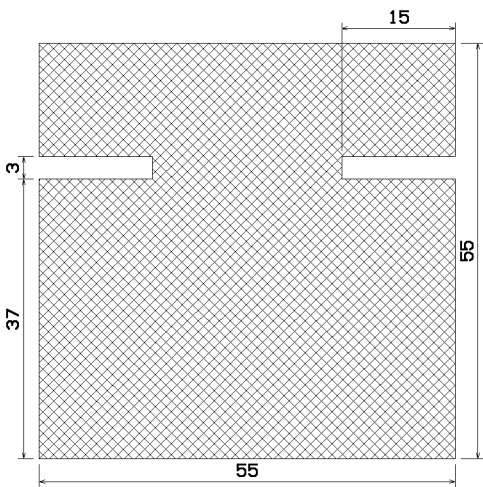

25798
EP/s/ 8186

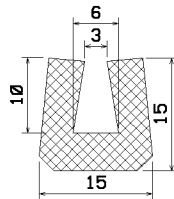

25799
EP/s/ 8194

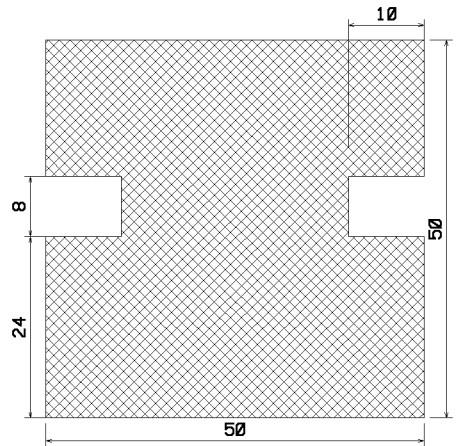

25800
EP/s/ 8205

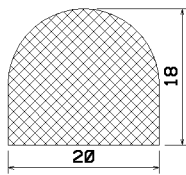

25801
EP/s/ 8267

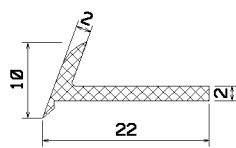

25802
EP/s/ 8253

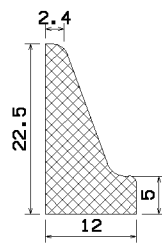

25803
EP/w/ 8268

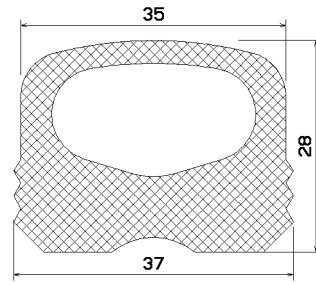

25804
EP/s/ 8303

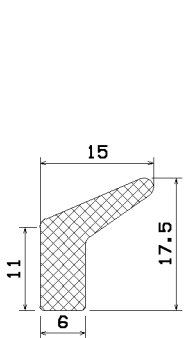

25805
EP/s/ 8308

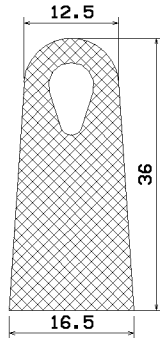

25806
EP/s/ 8339

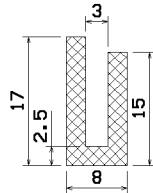

25807
EP/s/ 7402

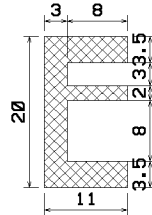

25808
EP/s/ 7443

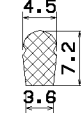

25809
EP/s/ 7491

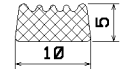

25810
EP/s/ ___/(8368)

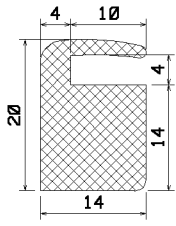

25811
EP/s/ 7504

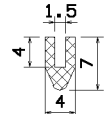

25813
EP/s/ 7502

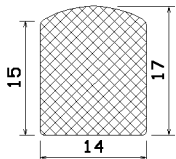

25814
EP/s/ 7525

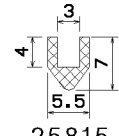

25815
EP/g/ 8408

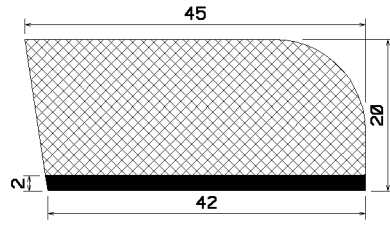

25816
EP/s/ 8722

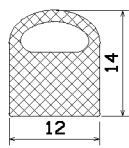

25817
NBR/g/ 8611

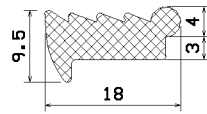

25818
EP/s/ 8668

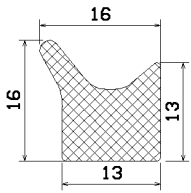

25819
EP/s/ 8701

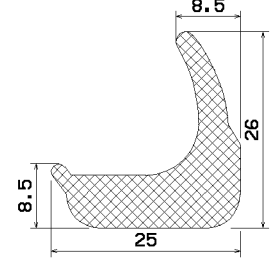

25820
EP/s/ 8716

25821

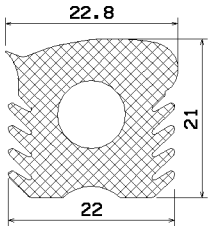

25822
EP/s/ 8779

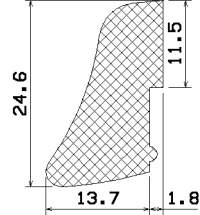

25823
EP/s/ 8769

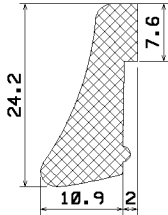

25824
EP/s/ 8771

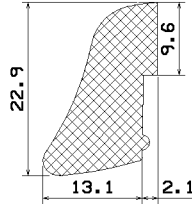

25825
EP/s/ 8770

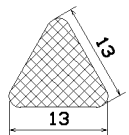

25826
EP/s/ 8795

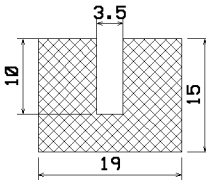

25827
EP/s/ 8813

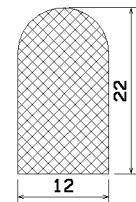

25828
NR/w/8859

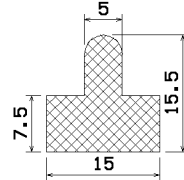

25829
EP/g/ 8924

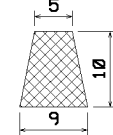

25831
FPM/s/ 8935

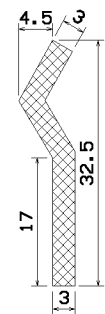

25832
EP/s/ 8927

